

ASOMEDICA CO. LTD.

# INVITATION TO COOPERATION

Asomedica Co. Ltd. manufactures medical devices widely used by healthcare institutions worldwide.

Becoming a global company in the field of medical consumables, we provide full support to our clients from the development stage through implementation.

- ☑ Wide range of manufactured medical consumables
- ☑ Possibility to implement exclusive custom orders
- ☑ Own modern high-tech manufacturing facility with a total area exceeding 7,800 m<sup>2</sup>
- ☑ Highly qualified personnel
- ☑ Excellent office and warehouse facilities
- ☑ Sales and after-sales support in every region
- ☑ Optimal price-quality ratio



ISO 13485



FDA

Asomedica Co. Ltd. is a European manufacturer of medical consumables and a distributor of medical equipment from leading global manufacturers. The company was founded in 2006 with the aim of studying, implementing and developing new technologies in everyday medical practice.

Many years of experience and the strong reputation of our company are confirmed by our intensive activity in the global market. We export our products to the markets of Europe, Asia, Africa, and the United States.

Our quality management system complies with ISO 13485 and FDA requirements, ensuring the consistent production of high-quality medical consumables.

All these factors make Asomedica Co. Ltd. a reliable partner.



# TABLE OF CONTENTS

## 01

### BREATHING CIRCUITS

TUBES	6
WITHOUT WATER TRAP	7
WITH ONE WATER TRAP	10
WITH TWO WATER TRAPS	12
NEONATAL (10M)	14
COAXIAL	17

## 02

### ANESTHESIA AND RESUSCITATION ACCESSORIES

BREATHING MASK	20
LARYNGEAL MASK	21
OXYGEN MASK	22
AEROSOL MASK	23
CPAP THERAPY MASK	24
BREATHING BAG	25
AMBU BREATHING BAG	26
BACTERIAL-VIRAL BREATHING FILTERS	28
TRACHEOSTOMY HEAT AND MOISTURE EXCHANGER	31
AIRWAYS	32
ACCESSORIES	33
MEDICAL CONNECTORS	35
LUER CAPS	38

# TABLE OF CONTENTS

## 03

### MEDICAL CATHETERS

NELATON MALE	40
FEMALE	41
TIEMANN MALE	42
FOLEY (TWO-WAY, THREE-WAY)	43
FEEDING	44
UMBILICAL	45
GASTRIC (TUBE)	46
SUCTION	47
SUCTION WITH VACUUM LEVEL CONTROL	48
RECTAL	49
LEVIN DUODENAL SUCTION	50
LEVIN DUODENAL FEEDING	51
OXYGEN	52
SURGICAL DRAINAGE	53
REDON TYPE	54
CONNECTING (TUBE)	55
TUBE IN COILS	56

## 04

### MEDICAL URINE BAGS

BEDSIDE URINE BAGS	58
LEG URINE BAGS	59
ESMARCH'S IRRIGATOR	60

# 01 BREATHING CIRCUITS

Breathing circuits are intended for respiratory support in intensive care, as well as for supplying and removing a controlled gas mixture to and from the patient.

Breathing circuits are made of polymer materials and may be supplied for single use in both sterile and non-sterile versions. Length range: 0.4-5.0 m.

Breathing circuits equipped with heating wires ensure the delivery of heated respiratory gas mixture and prevent condensation formation.

Breathing circuits can be supplied with various products and accessories. Components included in the circuit may be packaged individually and then placed together with the product in a common package or supplied alongside it.

**Breathing circuits manufactured by Asomedica Co. Ltd. are compatible with most mechanical ventilators (MV) and anesthesia machines (AM).**

## ADULT BREATHING CIRCUITS (22M)

## PEDIATRIC BREATHING CIRCUITS (15M)

## NEONATAL BREATHING CIRCUITS (10M)

*\*Specifications, types, dimensions, and quantities of products are determined by the customer and specified in the accompanying documentation and/or documentation related directly to the product.*

## BREATHING CIRCUIT WITHOUT WATER TRAP

## BREATHING CIRCUIT WITH ONE WATER TRAP

## BREATHING CIRCUIT WITH TWO WATER TRAPS

## COAXIAL CIRCUIT

## SYMBOLS USED IN THE CATALOG

---

<b>C</b>	Configurable corrugated
<b>N</b>	Non-configurable corrugated
<b>S</b>	Smooth-bore
<b>Cag</b>	Configurable corrugated antimicrobial (with silver ions)
<b>Nag</b>	Non-configurable corrugated antimicrobial (with silver ions)

# 01/1 BREATHING CIRCUITS TUBES

When manufacturing breathing circuits, the following types of tubes may be used:

## CONFIGURABLE CORRUGATED

- ✔ Lower volume during storage and transportation
- ✔ Adjustable length and dead space volume of the circuit
- ✔ Kink resistance
- ✔ High strength
- ✔ Color coding of inspiratory and expiratory lines

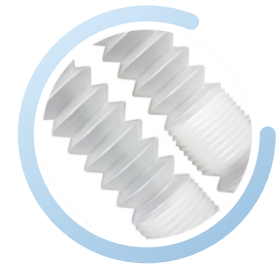
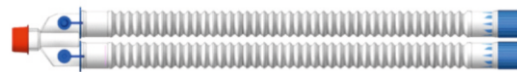

## NON-CONFIGURABLE CORRUGATED

- ✔ Soft and flexible
- ✔ Lightweight
- ✔ Cost-effective
- ✔ Color coding of inspiratory and expiratory lines

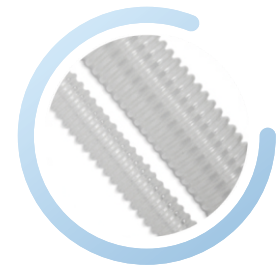

## CONFIGURABLE CORRUGATED NON-CONFIGURABLE CORRUGATED

- ✔ Prevents the growth of pathogenic bacteria due to the addition of active silver ions to the material (violet color coding)
- ✔ Significant reduction of hospital-acquired infections
- ✔ The antimicrobial activity of the circuit is confirmed by a state laboratory protocol.

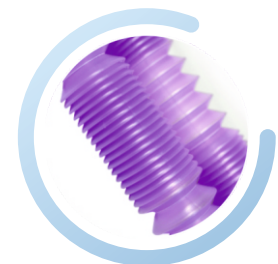
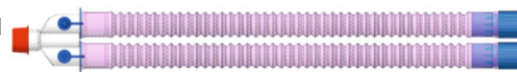

## SMOOTH-BORE

- ✔ Low flow resistance
- ✔ High strength due to reinforced surface
- ✔ Smooth inner surface reduces condensate accumulation
- ✔ Kink resistance
- ✔ Transparency

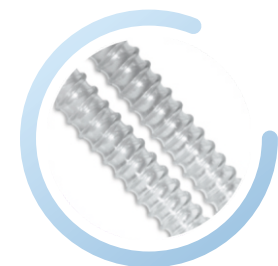

# 01/2 BREATHING CIRCUITS WITHOUT WATER TRAP

- ☑ Circuit length: 0.4 m to 5.0 m.
- ☑ Modification of the breathing circuit length and configuration is possible upon agreement with the customer.
- ☑ Non-sterile or sterilized with ethylene oxide.
- ☑ Sterile products are packaged in individual sterile packaging.
- ☑ Protection against moisture during storage.
- ☑ Non-pyrogenic, non-toxic, phthalate-free.



### Single-use, composition may include:

- Y-adapter (0-1 pc);
- Straight adapter (1-20 pcs);
- Straight elastic adapter (0-20 pcs);
- Straight flexible adapter (0-5 pcs);
- Angular adapter (0-5 pcs);
- Angular adapter with tube (0-5 pcs);
- Swivel adapter (0-5 pcs);
- T-connector (0-3 pcs);
- Filter with/without heat and moisture exchange (0-5 pcs);
- Humidifier (0-2 pcs);
- Tube (1-10 pcs);
- Breathing bag, volume: 500 ml, 1000 ml, 2000 ml, 3000 ml (0-5 pcs);
- Breathing mask, size: 0, 1, 2, 3, 4, 5, 6 (0-5 pcs);
- Laryngeal mask, size: 1; 1.5; 2; 2.5; 3; 4; 5 (0-5 pcs);
- Mask holder (0-5 pcs);
- Heating wire (0-2 pcs);
- Monitoring line (0-5 pcs);
- Flow restrictor (0-1 pc);
- Antimicrobial tube (0-10 pcs);
- Flow sensor (0-1 pc);
- Exhalation valve (0-1 pc);
- Cap (0-3 pcs);
- Fixation clip (0-5 pcs);
- Suction catheter with vacuum level control (0-5 pcs);
- Flow generator (0-5 pcs);
- Mask for non-invasive ventilation, size: S, M, L, XL (0-5 pcs);
- Mask for CPAP, size: S, M, L, XL (0-5 pcs);
- Cannula for CPAP, size: XS, S, M, L, XL, Medium Wide, Large Wide (0-5 pcs);
- Cap for CPAP, size: XS, S, M, L, XL, XXL, XXXXL (0-5 pcs);
- Connector with port for N<sub>2</sub>O (0-5 pcs)

### CONFIGURATION

- Tube (1 pc);
- Straight adapter (1 pc);
- Swivel adapter with tube (1 pc);
- Monitoring line (2 pcs);
- Flow sensor (1 pc);
- Exhalation valve (1 pc);
- Cap (1 pc);
- Fixation clip (1 pc)

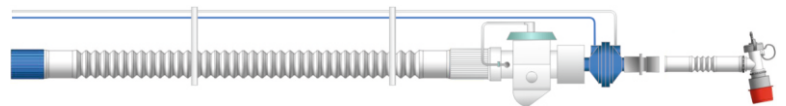

Ø 22M	3600N	3600S	3600Nag
Ø 15M	5900N	5900S	5900Nag

### CONFIGURATION

- Y-adapter (1 pc);
- Straight adapter (2 pcs);
- Tubes (2 pcs)



Ø 22M	3300C	3300N	3300S	3300Cag	3300Nag
Ø 15M	5500C	5500N	5500S	5500Cag	5500Nag

# 01/2 BREATHING CIRCUITS WITHOUT WATER TRAP

## CONFIGURATION

- Y-adapter (1 pc);
- Straight adapter (2 pcs);
- Angular adapter (1 pc);
- Tubes (2 pcs)



Ø 22M	3301C	3301N	3301S	3301Cag	3301Nag
Ø 15M	5501C	5501N	5501S	5501Cag	5501Nag

## CONFIGURATION

- Y-adapter (1 pc);
- Straight adapter (4 pcs);
- Angular adapter (1 pc);
- Tubes (3 pcs)

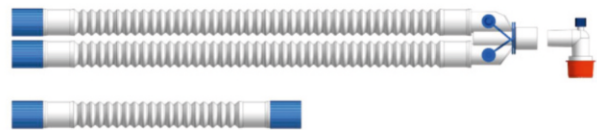

Ø 22M	3302C	3302N	3302S	3302Cag	3302Nag
Ø 15M	5502C	5502N	5502S	5502Cag	5502Nag

## CONFIGURATION

- Y-adapter (1 pc);
- Straight adapter (4 pcs);
- Swivel adapter (1 pc);
- Tubes (3 pcs)

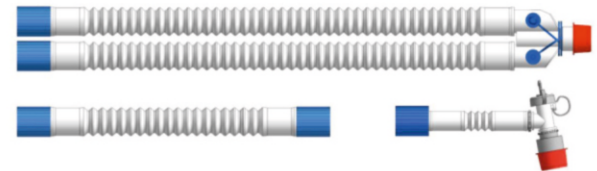

Ø 22M	3303C	3303N	3303S	3303Cag	3303Nag
Ø 15M	5503C	5503N	5503S	5503Cag	5503Nag

## CONFIGURATION

- Y-adapter (1 pc);
- Straight adapter (5 pcs);
- Angular adapter (1 pc);
- Tubes (3 pcs);
- Breathing bag (1 pc)

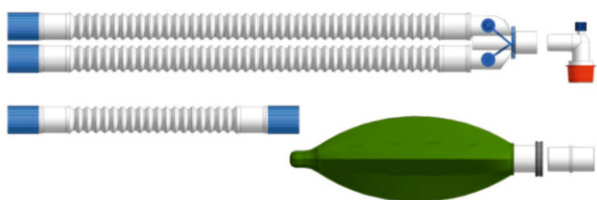

Ø 22M	3304C	3304N	3304S	3304Cag	3304Nag
Ø 15M	5504C	5504N	5504S	5504Cag	5504Nag

## CONFIGURATION

- Y-adapter (1 pc);
- Straight adapter (4 pcs);
- Angular adapter (1 pc);
- Tubes (3 pcs);
- Breathing mask (1 pc)

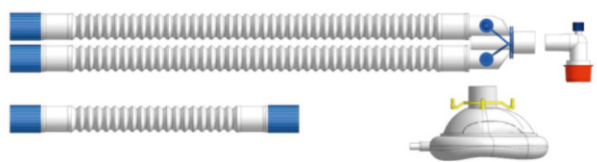

Ø 22M	3400C	3400N	3400S	3400Cag	3400Nag
Ø 15M	5600C	5600N	5600S	5600Cag	5600Nag

# 01/2 BREATHING CIRCUITS WITHOUT WATER TRAP

## CONFIGURATION

- Y-adapter (1 pc);
- Straight adapter (4 pcs);
- Swivel adapter (1 pc);
- Tubes (3 pcs);
- Breathing mask (1 pc)

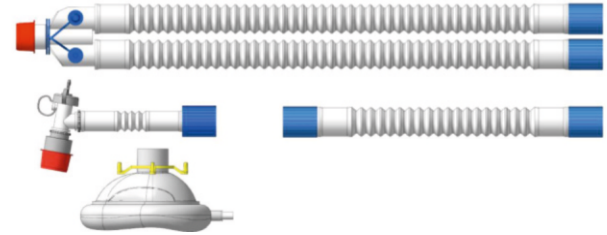

Ø 22M	3401C	3401N	3401S	3401Cag	3401Nag
Ø 15M	5601C	5601N	5601S	5601Cag	5601Nag

## CONFIGURATION

- Y-adapter (1 pc);
- Straight adapter (2 pcs);
- Angular adapter (1 pc);
- Filter with/without heat and moisture exchange (1 pc);
- Tubes (2 pcs)



Ø 22M	3500C	3500N	3500S	3500Cag	3500Nag
Ø 15M	5700C	5700N	5700S	5700Cag	5700Nag

## CONFIGURATION

- Y-adapter (1 pc);
- Straight adapter (5 pcs);
- Angular adapter (1 pc);
- Filter with/without heat and moisture exchange (1 pc);
- Tubes (3 pcs);
- Breathing bag (1 pc)

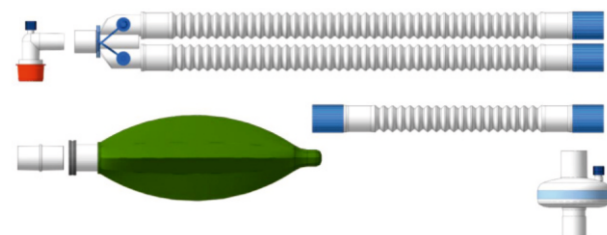

Ø 22M	3501C	3501N	3501S	3501Cag	3501Nag
Ø 15M	5701C	5701N	5701S	5701Cag	5701Nag

## CONFIGURATION

- Y-adapter (1 pc);
- Straight adapter (4 pcs);
- Angular adapter (1 pc);
- Filter with/without heat and moisture exchange (1 pc);
- Tubes (3 pcs);
- Breathing mask (1 pc)

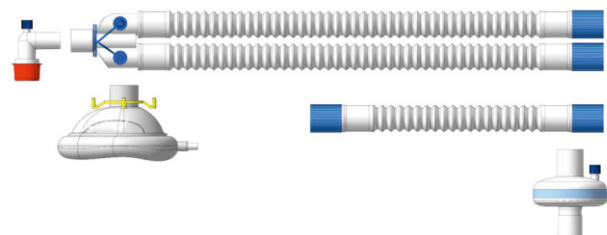

Ø 22M	3502C	3502N	3502S	3502Cag	3502Nag
Ø 15M	5702C	5702N	5702S	5702Cag	5702Nag

# 01/3 BREATHING CIRCUITS WITH ONE WATER TRAP

## Single-use, composition may include:

- Y-adapter (0-1 pc);
- Straight adapter (1-20 pcs);
- Angular adapter (0-5 pcs);
- Straight elastic adapter (0-20 pcs);
- Straight flexible adapter (0-5 pcs);
- Angular adapter with tube (0-5 pcs);
- Swivel adapter (0-5 pcs);
- T-connector (0-3 pcs);
- Water trap (1 pc);
- Filter with/without heat and moisture exchange (0-5 pcs);
- Humidifier (0-2 pcs);
- Tube (1-10 pcs);
- Breathing bag, volume: 500 ml, 1000 ml, 2000 ml, 3000 ml (0-5 pcs);
- Breathing mask, size: 0, 1, 2, 3, 4, 5, 6 (0-5 pcs);
- Laryngeal mask, size: 1; 1.5; 2; 2.5; 3; 4; 5 (0-5 pcs);
- Mask holder (0-5 pcs);
- Heating wire (0-2 pcs);
- Monitoring line (0-5 pcs);
- Flow restrictor (0-1 pc);
- Antimicrobial tube (0-10 pcs);
- Flow sensor (0-1 pc);

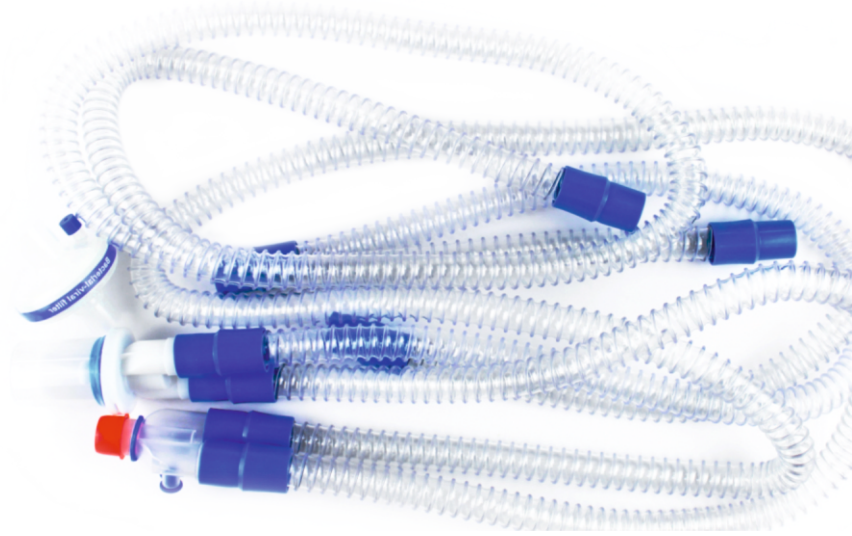

- Exhalation valve (0-1 pc);
- Cap (0-3 pcs);
- Nebulizer (0-5 pcs);
- Connecting catheter (tube) (0-5 pcs);
- Fixation clip (0-2 pcs);
- Oxygen tube (0-5 pcs);
- Suction catheter with vacuum level control (0-5 pcs);
- Connector with port for N<sub>2</sub>O (0-5 pcs)

## CONFIGURATION

- Y-adapter (1 pc);
- Straight adapter (4 pcs);
- Water trap (1 pc);
- Tubes (4 pcs)

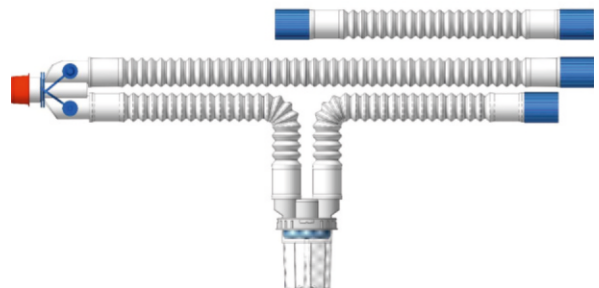

Ø 22M	3402C	3402N	3402S	3402Cag	3402Nag
Ø 15M	5602C	5602N	5602S	5602Cag	5602Nag

# 01/3 BREATHING CIRCUITS WITH ONE WATER TRAP

## CONFIGURATION

- Y-adapter (1 pc);
- Straight adapter (4 pcs);
- Swivel adapter (1 pc);
- Water trap (1 pc);
- Tubes (4 pcs)

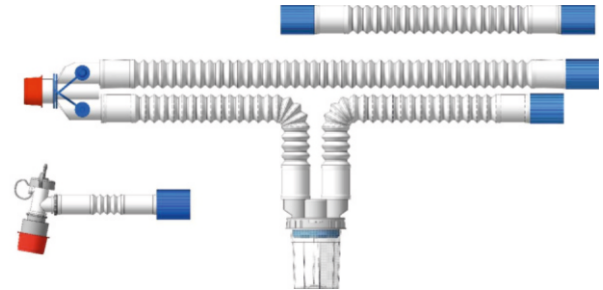

Ø 22M	3403C	3403N	3403S	3403Cag	3403Nag
Ø 15M	5603C	5603N	5603S	5603Cag	5603Nag

## CONFIGURATION

- Y-adapter (1 pc);
- Straight adapter (4 pcs);
- Water trap (1 pc);
- Filter with/without heat and moisture exchange (1 pc);
- Tubes (4 pcs)

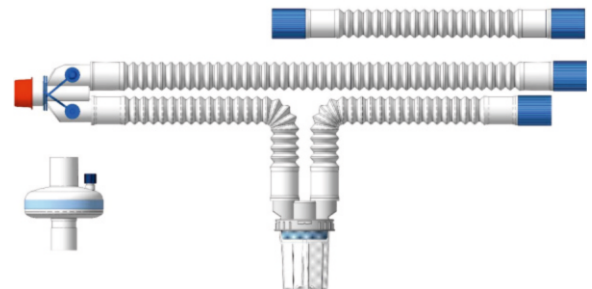

Ø 22M	3503C	3503N	3503S	3503Cag	3503Nag
Ø 15M	5703C	5703N	5703S	5703Cag	5703Nag

## CONFIGURATION

- Y-adapter (1 pc);
- Straight adapter (4 pcs);
- Angular adapter (1 pc);
- Water trap (1 pc);
- Filter with/without heat and moisture exchange (1 pc);
- Humidifier (1 pc);
- Tubes (4 pcs);
- Breathing mask (1 pc)

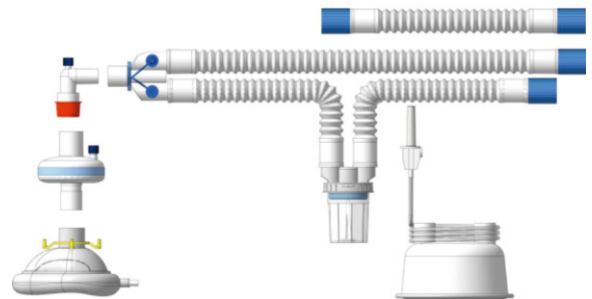

Ø 22M	3505C	3505N	3505S	3505Cag	3505Nag
Ø 15M	5705C	5705N	5705S	5705Cag	5705Nag

# 01 / 4 BREATHING CIRCUITS WITH TWO WATER TRAPS

## Single-use, composition may include:

- Y-adapter (0-1 pc);
- Straight adapter (1-20 pcs);
- Straight elastic adapter (0-20 pcs);
- Straight flexible adapter (0-5 pcs);
- Angular adapter (0-5 pcs);
- Angular adapter with tube (0-5 pcs);
- Swivel adapter (0-5 pcs);
- T-connector (0-3 pcs.);
- Water trap (2 pcs);
- Filter with/without heat and moisture exchange (0-5 pcs);
- Humidifier (0-2 pcs);
- Tube (1-10 pcs);
- Breathing bag, volume: 500 ml, 1000 ml, 2000 ml, 3000 ml (0-5 pcs);
- Breathing mask, size: 0, 1, 2, 3, 4, 5, 6 (0-5 pcs);
- Laryngeal mask, size: 1; 1.5; 2; 2.5; 3; 4; 5 (0-5 pcs);
- Mask holder (0-5 pcs);
- Heating wire (0-2 pcs);
- Monitoring line (0-5 pcs);
- Flow restrictor (0-1 pc);
- Antimicrobial tube (0-10 pcs);
- Flow sensor (0-1 pc);

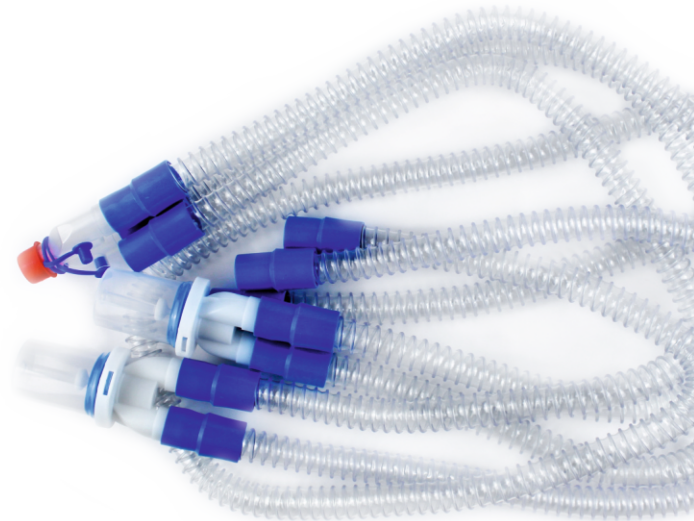

- Exhalation valve (0-1 pc);
- Cap (0-3 pcs);
- Nebulizer (0-5 pcs);
- Connecting catheter (tube) (0-5 pcs);
- Fixation clip (0-2 pcs);
- Oxygen tube (0-5 pcs);
- Suction catheter with vacuum level control (0-5 pcs);
- Connector with port for N<sub>2</sub>O (0-5 pcs)

## CONFIGURATION

- Y-adapter (1 pc);
- Straight adapter (4 pcs);
- Water trap (2 pcs);
- Tubes (5 pcs)

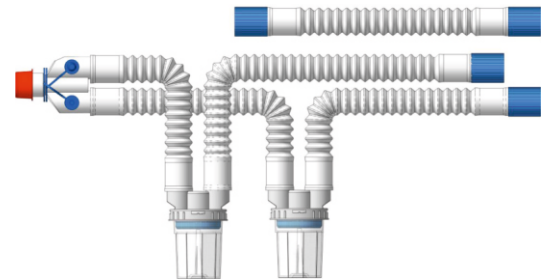

Ø 22M	3404C	3404N	3404S	3404Cag	3404Nag
Ø 15M	5604C	5604N	5604S	5604Cag	5604Nag

## CONFIGURATION

- Y-adapter (1 pc);
- Straight adapter (4 pcs);
- Swivel adapter (1 pc);
- Water trap (2 pcs);
- Tubes (5 pcs)

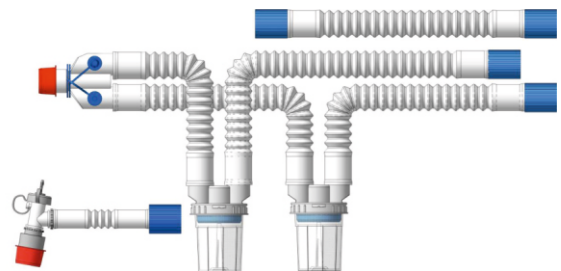

Ø 22M	3405C	3405N	3405S	3405Cag	3405Nag
Ø 15M	5605C	5605N	5605S	5605Cag	5605Nag

# 01/4 BREATHING CIRCUITS WITH TWO WATER TRAPS

## CONFIGURATION

- Y-adapter (1 pc);
- Straight adapter (4 pcs);
- Swivel adapter (1 pc);
- Water trap (2 pcs);
- Tubes (5 pcs);
- Breathing mask (1 pc)

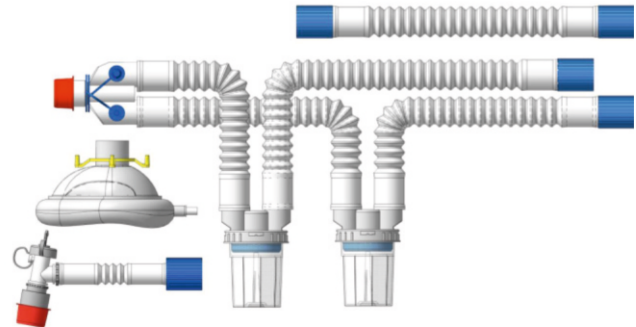

Ø 22M	3406C	3406N	3406S	3406Cag	3406Nag
Ø 15M	5606C	5606N	5606S	5606Cag	5606Nag

## CONFIGURATION

- Y-adapter (1 pc);
- Straight adapter (4 pcs);
- Water trap (2 pcs);
- Filter with/without heat and moisture exchange (1 pc);
- Tubes (5 pcs)

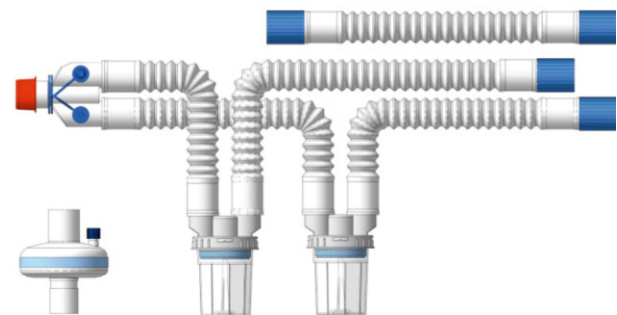

Ø 22M	3504C	3504N	3504S	3504Cag	3504Nag
Ø 15M	5704C	5704N	5704S	5704Cag	5704Nag

## CONFIGURATION

- Y-adapter (1 pc);
- Straight adapter (4 pcs);
- Swivel adapter (1 pc);
- Water trap (2 pcs);
- Filter with/without heat and moisture exchange (1 pc);
- Humidifier (1 pc);
- Tubes (5 pcs);
- Breathing mask (1 pc)

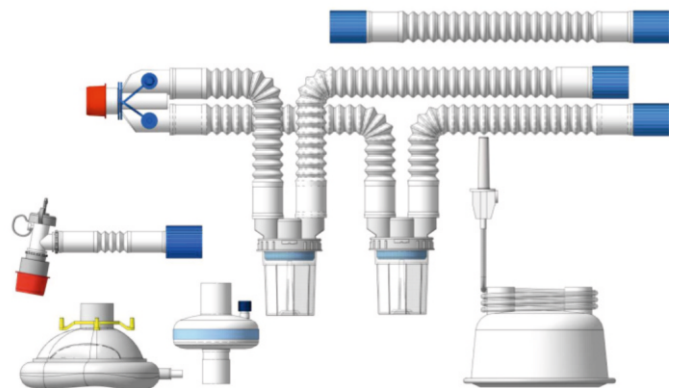

Ø 22M	3506C	3506N	3506S	3506Cag	3506Nag
Ø 15M	5706C	5706N	5706S	5706Cag	5706Nag

# 01/5 BREATHING CIRCUITS NEONATAL (10M)



Neonatal breathing circuits are intended for respiratory support in anesthesiology and neonatal intensive care and are compatible with most mechanical ventilators (MV) and anesthesia machines (AM).

- ✔ Sterile products are packaged in individual sterile packaging.
  - ✔ Protection against moisture during storage.
  - ✔ Non-pyrogenic, non-toxic, phthalate-free.
  - ✔ Non-sterile or sterilized with ethylene oxide.
  - ✔ Non-configurable corrugated or smooth-bore tube.
- 
- ✔ Breathing circuits equipped with heating wires ensure temperature control of the gas mixture delivered to the patient, providing optimal temperature conditions for mechanical ventilation and preventing condensation inside the circuit lumen.
  - ✔ Breathing circuits are supplied with various products and accessories.
  - ✔ Specifications, types, dimensions, and quantities of products are determined by the customer.
  - ✔ Components included in the circuit may be packed in separate packaging and then placed together with the product in a common package or supplied alongside it.



## Single-use, composition may include:

- Y-adapter (0-1 pc);
- Straight adapter (1-20 pcs);
- Straight elastic adapter (0-20 pcs);
- Straight flexible adapter (0-5 pcs);
- Angular adapter (0-5 pcs);
- Angular adapter with tube (0-5 pcs);
- Swivel adapter (0-5 pcs);
- T-connector (0-3 pcs.);
- Water trap (1 pc);
- Filter with/without heat and moisture exchange (0-5 pcs);
- Humidifier (0-2 pcs);
- Tube (1-10 pcs);
- Breathing bag, volume: 500 ml, 1000 ml (0-5 pcs);
- Breathing mask, size: 0, 1, 2, 3 (0-5 pcs);
- Laryngeal mask, size: 1; 1.5; 2; 2.5 (0-5 pcs);
- Mask holder (0-5 pcs);
- Heating wire (0-2 pcs);
- Monitoring line (0-5 pcs);
- Flow restrictor (0-1 pc);
- Flow sensor (0-1 pc);
- Exhalation valve (0-1 pc);
- Cap (0-3 pcs);
- Nebulizer (0-5 pcs);
- Connecting catheter (tube) (0-5 pcs);
- Fixation clip (0-5 pcs);
- Flow generator (0-5 pcs);
- Mask for non-invasive ventilation, size: S, M, L, XL (0-5 pcs);
- Mask for CPAP, size: S, M, L, XL (0-5 pcs);
- Cannula for CPAP, size: XS, S, M, L, XL, Medium Wide, Large Wide (0-5 pcs);
- Cap for CPAP, size: XS, S, M, L, XL, XXL, XXXXL (0-5 pcs);
- Oxygen tube (0-5 pcs);
- Suction catheter with vacuum level control (0-5 pcs);
- Connector with port for N<sub>2</sub>O (0-5 pcs)

# 01/5 BREATHING CIRCUITS NEONATAL (10M)

## BREATHING CIRCUIT WITHOUT WATER TRAP

### CONFIGURATION

- Y-adapter (1 pc);
- Straight adapter (2 pcs);
- Tube (2 pcs)



Ø 10M

6601N

6601S

## BREATHING CIRCUIT WITHOUT WATER TRAP

### CONFIGURATION

- Y-adapter (1 pc);
- Straight adapter (2 pcs);
- Filter with heat and moisture exchange (2 pcs);
- Tube (4 pcs)

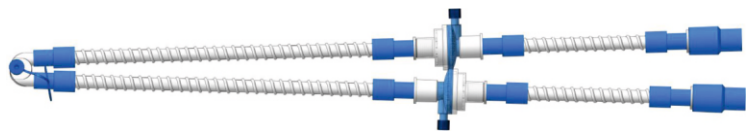

Ø 10M

6602N

6602S

## BREATHING CIRCUIT WITH TWO WATER TRAPS

### CONFIGURATION

- Y-adapter (1 pc);
- Straight adapter (10 pcs);
- Water trap (2 pcs);
- Humidifier (1 pc);
- Tube (5 pcs);
- Monitoring line (1 pc)

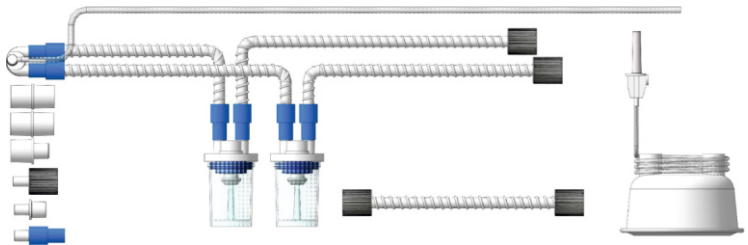

Ø 10M

6603N

6603S

## BREATHING CIRCUIT WITH ONE WATER TRAP

### CONFIGURATION

- Y-adapter (1 pc);
- Straight adapter (8 pcs);
- T-connector (1 pc);
- Water trap (1 pc);
- Humidifier (1 pc);
- Tube (5 pcs);
- Heating wire (1 pc)

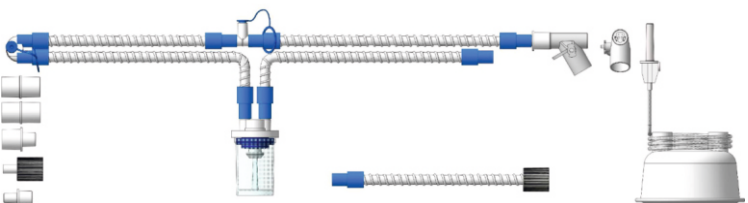

Ø 10M

6604N

6604S

# 01/5 BREATHING CIRCUITS NEONATAL (10M)

## BREATHING CIRCUIT WITH ONE WATER TRAP

### CONFIGURATION

- Y-adapter (1 pc);
- Straight adapter (8 pcs);
- T-connector (1 pc);
- Water trap (1 pc);
- Humidifier (1 pc);
- Tube (5 pcs);
- Heating wire (1 pc);
- Monitoring line (1 pc)

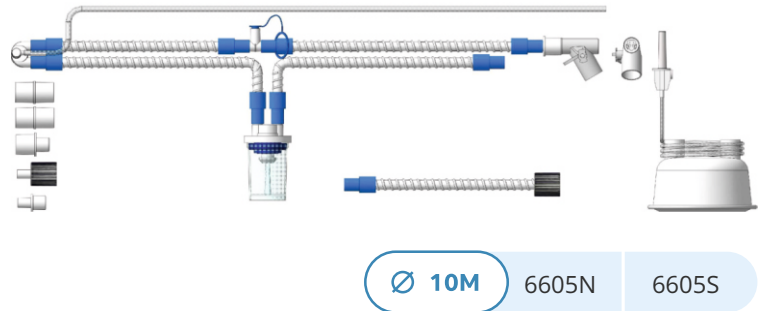

## BREATHING CIRCUIT WITH ONE WATER TRAP

### CONFIGURATION

- Y-adapter (1 pc);
- Straight adapter (8 pcs);
- T-connector (1 pc);
- Water trap (1 pc);
- Humidifier (1 pc);
- Tube (5 pcs);
- Heating wire (1 pc);
- Monitoring line (1 pc);
- Flow restrictor (1 pc)

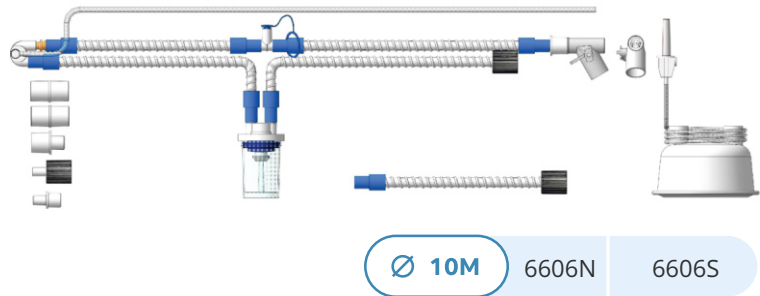

# 01/6 BREATHING CIRCUITS COAXIAL



A coaxial circuit is a breathing circuit in which the inspiratory line is located inside the expiratory line. The fresh gas mixture passing through the inner tube is warmed by the exhaled gases.

- ☑ Non-sterile or sterilized with ethylene oxide.
- ☑ Sterile products are packaged in individual sterile packaging.
- ☑ Protection against moisture during storage.
- ☑ Non-pyrogenic, non-toxic, phthalate-free.
- ☑ Shelf life (sterility) - 5 years from the date of manufacture.



## Single-use, composition may include:

- Straight adapter (1-20 pcs);
- Straight elastic adapter (0-20 pcs);
- Straight flexible adapter (0-5 pcs);
- Angular adapter (0-5 pcs);
- Angular adapter with tube (0-5 pcs);
- Swivel adapter (0-5 pcs);
- T-connector (0-3 pcs);
- Water trap (0-1 pc);
- Filter with/without heat and moisture exchange (0-5 pcs);
- Humidifier (0-2 pcs);
- Tube (1-10 pcs);
- Breathing bag, volume: 500 ml, 1000 ml, 2000 ml, 3000 ml (0-5 pcs);
- Breathing mask, size: 0, 1, 2, 3, 4, 5, 6 (0-5 pcs);
- Laryngeal mask, size: 1; 1.5; 2; 2.5; 3; 4; 5 (0-5 pcs);
- Mask holder (0-5 pcs);
- Monitoring line (0-5 pcs);
- Flow sensor (0-1 pc);
- Exhalation valve (0-1 pc);
- Cap (0-3 pcs);
- Fixation clip (0-5 pcs);
- Suction catheter with vacuum level control (0-5 pcs);
- Connector with port for N<sub>2</sub>O (0-5 pcs)

## CONFIGURATION

- Angular adapter (1 pc);
- Straight adapter (3 pcs);
- T-connector (1 pc);
- Tube (2 pcs)



Ø 26M	5800N	5800Nag
Ø 30M	4400N	4400Nag

# 01/6 BREATHING CIRCUITS COAXIAL

## CONFIGURATION

- Angular adapter (1 pc);
- Straight adapter (3 pcs);
- T-connector (1 pc);
- Tube (2 pcs);
- Monitoring line (1 pc)

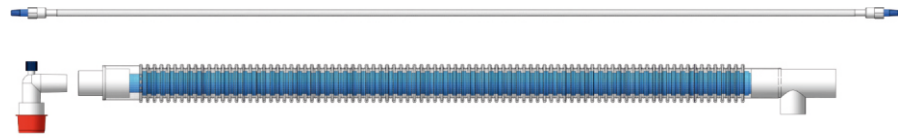

Ø 26M	5801N	5801Nag
Ø 30M	4401N	4401Nag

## CONFIGURATION

- Angular adapter (1 pc);
- Straight adapter (3 pcs);
- T-connector (1 pc);
- Tube (2 pcs);
- Breathing bag (1 pc)

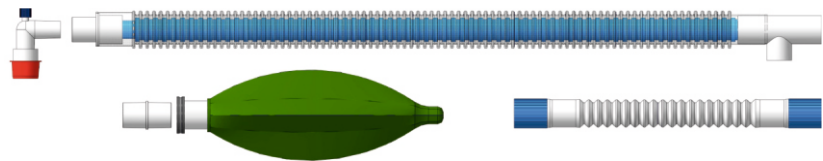

Ø 26M	5802N	5802Nag
Ø 30M	4402N	4402Nag

## BREATHING TUBE WITH ACCESSORIES (10M, 15M, 22M), LENGTH 0.4-50.0 m

### Single-use, composition may include:

- Straight adapter (0-10 pcs);
- Tube;
- Laryngeal mask, size: 1; 1.5; 2; 2.5; 3; 4; 5 (0 - 5 pcs);
- Oxygen mask, size: 1; 2; 3; 4; 5 (0 - 5 pcs);
- Aerosol mask with/without nebulizer, size: 1; 2; 3; 4; 5 (0 - 5 pcs);
- Filter with/without heat and moisture exchange (0-5 pcs)

# 02

## ANESTHESIA AND RESUSCITATION ACCESSORIES

Asomedica Co. Ltd. offers a wide range of anesthesia and resuscitation accessories.



### BREATHING MASK

### LARYNGEAL MASK

### OXYGEN AND AEROSOL MASK

### CPAP THERAPY MASK

### BREATHING BAG

### AMBU BREATHING BAG

### BACTERIAL-VIRAL BREATHING FILTERS

- ☑ Neonatal
- ☑ Pediatric
- ☑ Adult
- ☑ For spirometry

### TRACHEOSTOMY HEAT AND MOISTURE EXCHANGER

### AIRWAYS

### ACCESSORIES

- ☑ Valve
- ☑ Humidifier chamber
- ☑ Monitoring line
- ☑ Flow sensor
- ☑ Connector with port for N<sub>2</sub>O
- ☑ Nebulizer
- ☑ Mask holder
- ☑ Single-use endotracheal tube
- ☑ Single-use tracheostomy tube
- ☑ Single-use closed suction system

### MEDICAL CONNECTORS

- ☑ Y-adapter
- ☑ Elastic adapter
- ☑ Straight adapter
- ☑ Angular adapter
- ☑ Swivel adapter
- ☑ T-connector

### LUER CAPS

# 02/1 ANESTHESIA AND RESUSCITATION ACCESSORIES

## BREATHING MASK



The breathing mask is intended for mask mechanical ventilation or for the delivery of anesthetic gases, including use with manual resuscitation systems.

- ✔ Non-sterile or sterilized with ethylene oxide.
- ✔ Protection against moisture during storage.
- ✔ Latex-free.
- ✔ Non-pyrogenic, non-toxic, phthalate-free.
- ✔ Shelf life (sterility) - 5 years from the date of manufacture.
- ✔ Individually packaged.



### SINGLE-USE BREATHING MASK

- ✔ The single-use breathing mask is made of polymer materials.
- ✔ Equipped with a soft inflatable cuff that provides atraumatic, airtight sealing of the mask to the patient's face with minimal effort.
- ✔ The mask has a nipple valve for cuff inflation.
- ✔ A standard syringe is suitable for inflating the cuff.
- ✔ The transparent material of the mask allows visual monitoring of mucous membranes and skin condition, as well as observation of the patient's general condition.
- ✔ Masks are equipped with standard connectors (sizes: 0, 1 - 15M; sizes: 2, 3, 4, 5, 6 - 22F) for connection to breathing circuit components and a removable retaining ring marked with color depending on the mask size.

Sizes: 0; 1; 2; 3; 4; 5; 6.

SIZE	PATIENT CATEGORY
0	
1	
2	
3	
4	
5	
6	

### REUSABLE BREATHING MASK

- ✔ The reusable breathing mask is made of silicone.
- ✔ The silicone material provides tight sealing and enhanced patient comfort.
- ✔ The transparent material of the mask allows visual monitoring of mucous membranes and skin condition, as well as observation of the patient's general condition.
- ✔ Masks have standard connectors (sizes: 0, 1 - 15F; sizes: 2, 3, 4, 5 - 22F) for connection to breathing circuit components.

Sizes: 0; 1; 2; 3; 4; 5.

Can be supplied with a mask holder.



# 02/2 ANESTHESIA AND RESUSCITATION ACCESSORIES

## LARYNGEAL MASK



A laryngeal mask (LM) is intended for delivering anesthetic gas mixtures and maintaining upper airway patency during short-term anesthesia procedures (in fasting patients), in cases of difficult intubation, and during cardiopulmonary resuscitation.

- ✔ Sterile products are packaged in individual sterile packaging.
- ✔ Protection against moisture during storage.
- ✔ Latex-free.
- ✔ Non-pyrogenic, non-toxic, phthalate-free.
- ✔ Shelf life (sterility) - 5 years from the date of manufacture.

- ✔ Single-use with/without reinforcement  
Size: 1; 1.5; 2; 2.5; 3; 4; 5.
- ✔ Single-use silicone with/without reinforcement  
Size: 1; 1.5; 2; 2.5; 3; 4; 5.
- ✔ Reusable  
Size: 1; 1.5; 2; 2.5; 3; 4; 5.

- ✔ The single-use LM is made of high-quality thermoplastic implant-grade non-toxic PVC or silicone. The reusable LM is made of high-quality silicone, providing smooth insertion.
- ✔ The airway tube has an anatomical curvature, a large lumen diameter, is equipped with a standard 15 mm connector, and may be reinforced.
- ✔ The tube is marked with: mask size, cuff volume and patient weight range.
- ✔ The transparent tube material allows easy monitoring of condensation and fluids that may appear inside the tube.
- ✔ The LM is equipped with a soft inflatable cuff, ensuring reliable sealing with minimal risk of damage to the oropharyngeal tissues.



### CONFIGURATION

- Airway
- Inflatable cuff
- Inflation line
- Inflation valve
- Pilot balloon for pressure monitoring
- Non-return valve

SIZE	PATIENT CATEGORY
1	
1.5	
2	
2.5	
3	
4	
5	

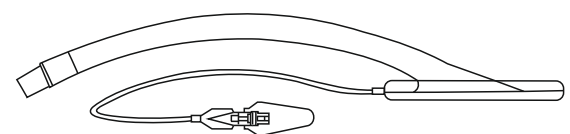

# 02/3 ANESTHESIA AND RESUSCITATION ACCESSORIES

## OXYGEN MASK



The product is intended for short-term delivery of medium and high concentrations of oxygen, as well as for inhalation therapy. It can be used in both inpatient and outpatient settings.

- ✔ Non-sterile or sterilized with ethylene oxide.
- ✔ Protection against moisture during storage.
- ✔ Latex-free.
- ✔ Non-pyrogenic, non-toxic, phthalate-free.
- ✔ Shelf life (sterility) - 5 years from the date of manufacture.
- ✔ Individually packaged.



### OXYGEN MASK

- ✔ Single-use  
Size: 1; 2; 3; 4; 5.
- ✔ The mask may be supplied with a reservoir bag and tube (tube length from 1000 mm to 5000 mm)

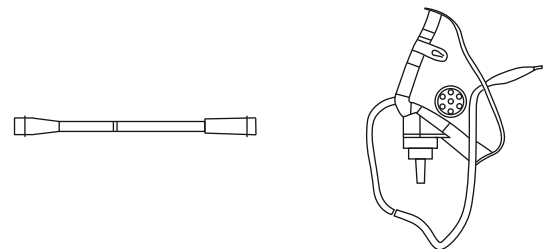

- ✔ The mask is made of soft elastic polymer material.
- ✔ It is easily fixed on the patient's face using an elastic strap and flexible nose clip (to prevent injury to newborns, the mask size 1 is supplied without a nose clip).
- ✔ The edges of the mask are atraumatic: rounded and smooth, ensuring high patient comfort.
- ✔ Openings on the side surfaces of the mask provide proper ventilation.
- ✔ The transparent material of the mask allows visual monitoring of the patient's mucous membranes and skin condition.
- ✔ The thermoplastic material of the mask softens at body temperature, preventing discomfort for the patient.
- ✔ In versions with a reservoir bag, the side openings are equipped with valves, allowing maximum oxygen concentration to be achieved.

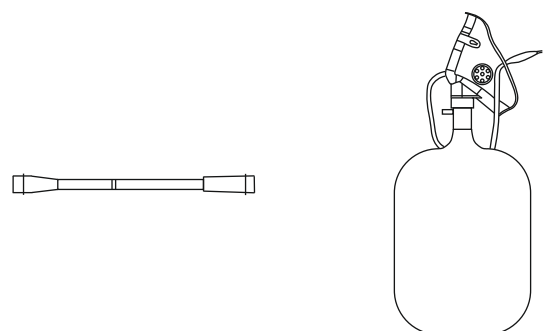

# 02/4 ANESTHESIA AND RESUSCITATION ACCESSORIES

## AEROSOL MASK



The product is intended for short-term delivery of medium and high concentrations of oxygen, as well as for inhalation therapy. It can be used in both inpatient and outpatient settings.

- ✔ Non-sterile or sterilized with ethylene oxide.
- ✔ Individually packaged.
- ✔ Protection against moisture during storage.
- ✔ Latex-free.
- ✔ Non-pyrogenic, non-toxic, phthalate-free.
- ✔ Shelf life (sterility) - 5 years from the date of manufacture.



### AEROSOL MASK

- ✔ Single-use Size: 2; 3; 4; 5.
- ✔ Masks may be supplied with tube (length from 1000 to 5000 mm), nebulizer, Venturi valve, flexible nose clip and disc valve.

**For the fastest visual identification of the valve, color coding is applied, where each color corresponds to a specific oxygen concentration.**

- ✔ The mask is made of soft elastic polymer material.
- ✔ It is easily fixed on the patient's face using an elastic strap and flexible nose clip (to prevent injury to newborns, the mask size 1 is supplied without a nose clip).
- ✔ The edges of the mask are atraumatic: rounded and smooth, ensuring high patient comfort.
- ✔ Openings on the side surfaces of the mask provide proper ventilation.
- ✔ The transparent material of the mask allows visual monitoring of the patient's mucous membranes and skin condition, as well as monitoring the patient's breathing.
- ✔ The thermoplastic material of the mask softens at body temperature, preventing discomfort for the patient.

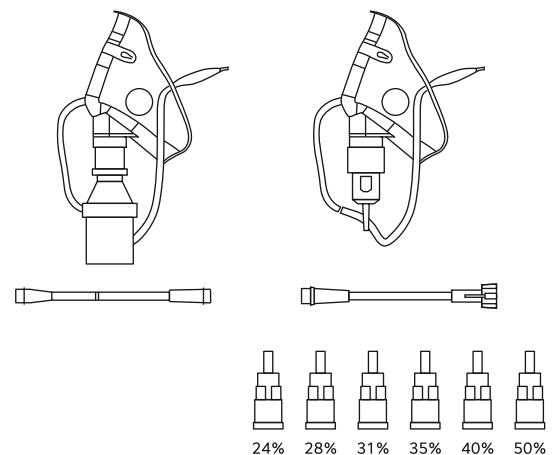

### OXYGEN CONCENTRATION, %

24
28
31
35
40
50
60

### OXYGEN FLOW RATE, LITERS PER MINUTE (L / MIN)

4
4
6
8
8
8
8

# 02/5 ANESTHESIA AND RESUSCITATION ACCESSORIES

## MASK FOR CPAP THERAPY



Designed to ensure uniform delivery of air/oxygen into the airways through the nose under low pressure without insertion of a tube into the trachea.

- ✔ Non-sterile or sterilized with ethylene oxide.
- ✔ Protection against moisture during storage.
- ✔ Latex-free.
- ✔ Non-pyrogenic, non-toxic, phthalate-free.
- ✔ Shelf life (sterility) - 5 years from the date of manufacture.
- ✔ Individually packaged.



- ✔ The single-use mask is made of soft elastic plasticized polymer material.
- ✔ The reusable mask is made of silicone.
- ✔ The mask is equipped with an inhalation valve, allowing breathing in case of insufficient flow or blockage of the inhalation line.
- ✔ For maximum tightness and patient comfort, the mask includes an inflation valve.
- ✔ The transparent material of the mask allows visual monitoring of mucous membranes and skin condition, as well as observation of the patient's general condition.

Sizes: S, M, L, XL

May be supplied with a head fixation strap.

# 02/6 ANESTHESIA AND RESUSCITATION ACCESSORIES

## BREATHING BAG



The breathing bag is used with any type of breathing equipment. It serves to collect exhaled air and supply the required volume of air during inhalation.

- ✔ Non-sterile or sterilized with ethylene oxide.
- ✔ Non-pyrogenic, non-toxic, phthalate-free.
- ✔ Shelf life (sterility) - 5 years from the date of manufacture.
- ✔ Individually packaged.



The product is intended for ensuring airtightness of the circuit during ventilator testing.

For preventing foreign objects from entering the breathing circuit. Performing lung ventilation as part of the breathing circuit.

- ✔ The single-use breathing bag is made of latex-free neoprene or latex; the reusable breathing bag is made of silicone.
- ✔ Single-use and reusable breathing bags are available in the following volumes: 500 ml, 1000 ml, 2000 ml, 3000 ml.
- ✔ The bag is equipped with an internal anti-sticking system and reinforced with transverse ribs for improved grip.
- ✔ The connection point between the bag and the connector is additionally reinforced with an external sealing adhesive strip.
- ✔ The volume of the breathing bag must not be less than the maximum inspiratory volume of a person.
- ✔ The bag has a 22F outlet and may additionally be supplied with an adapter 22M/15F-22M.



### CONFIGURATION

- Breathing bag
- Connector
- Adapter (if required) with outlets 22M-22M/15F

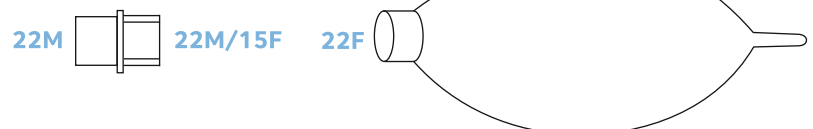

# 02/7 ANESTHESIA AND RESUSCITATION ACCESSORIES

## AMBU BREATHING BAG

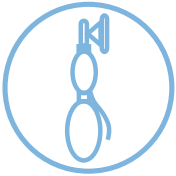

Designed for manual mechanical ventilation in cases of respiratory failure of any etiology.

- ✔ Non-sterile or sterilized with ethylene oxide.
- ✔ The reusable Ambu breathing bag has a detachable configuration, allowing full disinfection.
- ✔ Sterilization of the reusable Ambu breathing bag is permitted (except the oxygen tube and reservoir bag) in accordance with the mode specified in the sterilizer manufacturer's operating instructions.
- ✔ Protection against moisture during storage.
- ✔ Non-pyrogenic, non-toxic, phthalate-free.
- ✔ Shelf life (sterility) - 5 years from the date of manufacture.
- ✔ Individually packaged.



### AMBU BREATHING BAG SINGLE-USE AND REUSABLE

- ✔ The single-use breathing bag is made of medical PVC, and the reusable version is made of silicone.
- ✔ The resuscitation bag is available in volumes from 250 to 1630 ml, and the reservoir bag from 600 to 2600 ml.
- ✔ It can be connected to an external oxygen source using an oxygen tube.
- ✔ The operating principle is based on forced air delivery to the lungs through a face mask by manually compressing the resuscitation bag.
- ✔ The reservoir bag can be used for continuous oxygen supply and assisted ventilation.
- ✔ Equipped with a pressure control valve. The pressure control valve releases incoming air into the atmosphere if the pressure exceeds:  $600 \pm 100 \text{ mm H}_2\text{O}$  or  $400 \pm 50 \text{ mm H}_2\text{O}$ , preventing barotrauma to the patient.
- ✔ A port for connecting an oxygen reservoir is provided.
- ✔ The mask/endotracheal tube connection port is transparent, allowing visual monitoring of the inhalation valve operation.
- ✔ The transparent mask material facilitates observation of the patient's skin color and general condition.



# 02/7 ANESTHESIA AND RESUSCITATION ACCESSORIES

## AMBU BREATHING BAG

### CONFIGURATION

- Resuscitation bag
- Breathing mask
- Oxygen tube
- Reservoir bag
- Pressure control valve

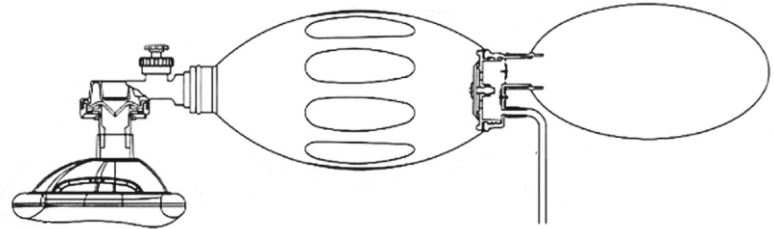

### OPTIONAL

- Airway
- Mouth opener
- Case

	Neonatal	Pediatric	Adult
Body weight, kg	≤ 10	10 - 33	≥33
Resuscitation bag volume, ml	250-340	550-680	1500-1630
Reservoir bag volume, ml	600-1600	1600-2600	1600-2600
Breathing mask size	0, 1, 2	2, 3, 4	3, 4, 5, 6
Oxygen tube length, mm	1000-3500	1000-3500	1000-3500
Airway, size	0000, 000, 00, 0	01, 02, 03	03, 04, 05, 06

# 02/8 ANESTHESIA AND RESUSCITATION ACCESSORIES

## BREATHING FILTERS



Breathing filters provide filtration of incoming air through a mechanical or electrostatic membrane.

- ✔ Sterile products are packaged in individual sterile packaging.
- ✔ Single-use product.
- ✔ Intended for single-patient use for no longer than 24 hours.
- ✔ Protection against moisture during storage.
- ✔ Non-pyrogenic, non-toxic, phthalate-free.
- ✔ Shelf life (sterility) - 5 years from the date of manufacture.

### SINGLE-USE BACTERIAL-VIRAL BREATHING FILTER

- ✔ Provides maximum bacterial and viral filtration of the respiratory gas mixture (filtration efficiency not less than 99.999%) combined with low flow resistance. Filtration methods: electrostatic, mechanical.
- ✔ Prevents cross-contamination of the patient's airways through breathing circuit components.
- ✔ Protects the patient from pathogenic microflora in the humidifier.
- ✔ Reduces the risk of airborne infection transmission through respiratory therapy equipment for both personnel and patients.
- ✔ The filter may include a heat and moisture exchanger (HME) made of hydrophobic material or foam material. In combination with air filtration, it imitates the natural humidification of the upper respiratory tract by collecting heat and moisture from the patient's exhaled air; the accumulated heat and moisture warm and humidify the inhaled air.
- ✔ The filter has standardized connectors for connection with breathing circuits and other medical devices.
- ✔ A Luer-lock port for capnography (CO<sub>2</sub>), protective cap, and elastic plug may be available. The filter housing includes marking indicating orientation toward the patient ("patient side").
- ✔ The lightweight version of bacterial-viral filters, due to its low weight, does not exert additional pressure on the patient's airway tissues.
- ✔ The spirometry filter provides maximum bacterial and viral filtration (filtration efficiency not less than 99.999%) of exhaled/inhaled air, prevents infectious agents from entering spirometry equipment and the surrounding air during examination, thereby ensuring protection of patients and medical personnel, also has low airflow resistance, which ensures high measurement accuracy.



# 02/8 ANESTHESIA AND RESUSCITATION ACCESSORIES

## BREATHING FILTERS

### Classification of breathing filters and heat and moisture exchangers

	Without heat and moisture exchange		With heat and moisture exchange (foam material)		With heat and moisture exchange (hydrophobic paper)	
	Electrostatic membrane	Mechanical membrane	Electrostatic membrane	Mechanical membrane	Electrostatic membrane	Mechanical membrane
<b>NEONATAL BACTERIAL-VIRAL BREATHING FILTERS</b>						
Luer port with protective cap	FL 10114	-	FL 11114	-	FL 12114	-
<b>PEDIATRIC BACTERIAL-VIRAL BREATHING FILTERS</b>						
Luer port with protective cap	FL 20111	FL 20123	FL 21111 FL 21113	-	FL 22111	-
<b>ADULT BACTERIAL-VIRAL BREATHING FILTERS</b>						
Without port	FL 30011 FL 30012	FL 30021	FL 31011	-	-	-
Luer port with protective cap	FL 30111	FL 30121	FL 31111	FL 31121	F132111	-
Luer port with protective cap, light weight	FL 30111L	-	-	-	-	-
<b>BACTERIAL-VIRAL BREATHING FILTERS FOR SPIROGRAPHY</b>						
Without port	FL 40016 FL 40017 FL 40018 FL 40019 FL 40020	-	-	-	-	-

### 1.1 Neonatal

#### FL10114 WITHOUT HEAT AND MOISTURE EXCHANGE

- Electrostatic membrane
- Port with protective cap
- Connector sizes 15F-15M/8M

#### FL11114 WITH HEAT AND MOISTURE EXCHANGE (FOAM MATERIAL)

- Electrostatic membrane
- Port with protective cap
- Connector sizes 15F-15M/8M

#### FL12114 WITH HEAT AND MOISTURE EXCHANGE (HYDROPHOBIC PAPER)

- Electrostatic membrane
- Port with protective cap
- Connector sizes 15F-15M/8M

# 02/8 ANESTHESIA AND RESUSCITATION ACCESSORIES

## BREATHING FILTERS

### 1.2 Pediatric

#### FL20111 WITHOUT HEAT AND MOISTURE EXCHANGE

- Electrostatic membrane
- Port with protective cap
- Connector sizes 22F/15M-22M/15F

#### FL21111 WITH HEAT AND MOISTURE EXCHANGE (FOAM MATERIAL)

- Electrostatic membrane
- Port with protective cap
- Connector sizes 22F/15M-22M/15F

#### FL22111 WITH HEAT AND MOISTURE EXCHANGE (HYDROPHOBIC PAPER)

- Electrostatic membrane
- Port with protective cap
- Connector sizes 22F/15M-22M/15F

#### FL20123 WITHOUT HEAT AND MOISTURE EXCHANGE

- Mechanical membrane
- Port with protective cap
- Connector sizes 15M-22M/15F

#### FL21113 WITH HEAT AND MOISTURE EXCHANGE (FOAM MATERIAL)

- Electrostatic membrane
- Port with protective cap
- Connector sizes 15M-22M/15F

### 1.3 Adult

#### FL30011 WITHOUT HEAT AND MOISTURE EXCHANGE

- Electrostatic membrane
- Without port
- Connector sizes 22F/15M-22M/15F

#### FL30021 WITHOUT HEAT AND MOISTURE EXCHANGE

- Mechanical membrane
- Without port
- Connector sizes 22F/15M-22M/15F

#### FL30121 WITHOUT HEAT AND MOISTURE EXCHANGE

- Mechanical membrane
- Port with protective cap
- Connector sizes 22F/15M-22M/15F

#### FL31011 WITH HEAT AND MOISTURE EXCHANGE (FOAM MATERIAL)

- Electrostatic membrane
- Without port
- Connector sizes 22F/15M-22M/15F

#### FL31121 WITH HEAT AND MOISTURE EXCHANGE (FOAM MATERIAL)

- Mechanical membrane
- Port with protective cap
- Connector sizes 22F/15M-22M/15F

#### FL30012 WITHOUT HEAT AND MOISTURE EXCHANGE

- Electrostatic membrane
- Without port
- Connector sizes 22F-22M/15F

#### FL30111L WITHOUT HEAT AND MOISTURE EXCHANGE

- Electrostatic membrane
- Port with protective cap
- Connector sizes 22F/15M-22M/15F
- Weight not more than 19 g

#### FL30111 WITHOUT HEAT AND MOISTURE EXCHANGE

- Electrostatic membrane
- Port with protective cap
- Output sizes 22F/15M-22M/15F

#### FL31111 WITH HEAT AND MOISTURE EXCHANGE (FOAM MATERIAL)

- Electrostatic membrane
- Port with protective cap
- Output sizes 22F/15M-22M/15F

#### FL32111 WITH HEAT AND MOISTURE EXCHANGE (HYDROPHOBIC PAPER)

- Electrostatic membrane
- Port with protective cap
- Output sizes 22F/15M-22M/15F

### 1.4 For Spirometry

#### FL40016

- Electrostatic membrane
- Connector sizes 30F-30M

#### FL40019

- Electrostatic membrane
- Connector sizes 26F-ellipse

#### FL40017

- Electrostatic membrane
- Connector sizes 30F-ellipse

#### FL40020

- Electrostatic membrane
- Connector sizes 24F-ellipse

#### FL40018

- Electrostatic membrane
- Connector sizes 28F-ellipse

# 02/9 ANESTHESIA AND RESUSCITATION ACCESSORIES

## TRACHEOSTOMY HEAT AND MOISTURE EXCHANGER



The heat and moisture exchanger for tracheostomy is intended for warming and humidifying the respiratory gas mixture, preventing condensation formation in breathing tubes and thereby reducing the possible risk of cross-contamination.

- ☑ Sterile products are packaged in individual sterile packaging.
- ☑ Single-use product.
- ☑ Intended for single-patient use for no longer than 24 hours.
- ☑ Protection against moisture during storage.
- ☑ Non-pyrogenic, non-toxic, phthalate-free.
- ☑ Shelf life (sterility) - 5 years from the date of manufacture.



- ☑ The heat and moisture exchanger for tracheostomy is made of polymer materials.
- ☑ It purifies inhaled air from dust and contaminants, humidifies it, and equalizes the temperature of incoming air in patients with a tracheostomy.
- ☑ The use of various anesthetic gases does not affect the performance of the heat and moisture exchanger.
- ☑ The humidifying element may be made of hydrophobic paper or foam material, allowing the air to be filtered, humidified, and warmed.

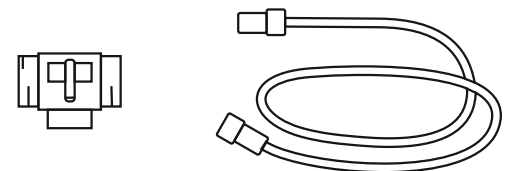

### Breathing filters and heat and moisture exchangers: single-use heat and moisture exchanger for tracheostomy

#### 2.1 FOAM MATERIAL

##### FL51005

- Without ports
- Connector size 15F

##### FL51205

- Port for oxygen tube
- Port for sanitation
- Connector size 15F

##### FL51305

- Port for oxygen tube
- Port for sanitation
- Oxygen tube (1000-5000 mm)
- Connector size 15F

#### 2.2 FROM HYDROPHOBIC PAPER

##### FL52005

- Without ports
- Connector size 15F

##### FL52205

- Port for oxygen tube
- Port for sanitation
- Connector size 15F

##### FL52305

- Port for oxygen tube
- Port for sanitation
- Oxygen tube (1000-5000 mm)
- Connector size 15F

	Foam material	Hydrophobic paper
Without ports, without oxygen tube	FL 51005	FL 52005
With oxygen tube port and sanitation port, without oxygen tube	FL 51205	FL 52205
With oxygen tube port and sanitation port, with oxygen tube	FL 51305	FL 52305

# 02/10 ANESTHESIA AND RESUSCITATION ACCESSORIES

## AIRWAYS



Airways are intended for restoring and maintaining upper airway patency during resuscitation procedures in unconscious patients. They may also be used as connectors for oxygen and aerosol humidification therapy.

- ✔ Sterile products are packaged in individual sterile packaging.
- ✔ Single-use product.
- ✔ Protection against moisture during storage.
- ✔ Non-pyrogenic, non-toxic, phthalate-free.
- ✔ Shelf life (sterility) - 5 years from the date of manufacture.



- ✔ The single-use medical airway is made of polymer materials.
- ✔ It consists of a curved hollow tube (oval cross-section flattened in the anteroposterior direction), whose anatomical shape follows the curvature of the tongue and palate, and a limiting flange that prevents the airway from slipping into the mouth.
- ✔ Airways have a smooth shape, rounded atraumatic edges, and a reinforced bite section preventing the airway from being bitten through.



For quick and easy size identification, airways are color-coded according to size.

000	00	0	01	02	03	04	05	06
40 mm	50 mm	60 mm	70 mm	80 mm	90 mm	100 mm	110 mm	120 mm

# 02/11 ANESTHESIA AND RESUSCITATION ACCESSORIES

## ACCESSORIES

### VALVE

Designed for installation in breathing circuits supporting intermittent positive pressure breathing (IPPB).

#### TYPE 1

- ✔ Straight connector 22M-22M/15F
- ✔ Valve control port

#### TYPE 2

- ✔ Straight connector 22M-22M/15F
- ✔ Valve control port
- ✔ Pressure measurement port

#### TYPE 3

- ✔ Straight connector 22M-22F
- ✔ Valve control port



### HUMIDIFIER CHAMBER

#### WITH AUTO-FILL

Designed for active heating and humidification of gases delivered to the patient during mechanical ventilation.

- ✔ Transparent housing
- ✔ Non-stick bottom
- ✔ Two portes 22M inlet/outlet
- ✔ Float dosing valve
- ✔ Liquid supply tube with a needle (with protective cap)
- ✔ Pressure equalization port



### MONITORING LINE

Designed for monitoring of respiratory gases /pressure in breathing circuits.

- ✔ PVC tubes of various lengths
- ✔ Luer connectors or connection ports/outlets are installed at the tube ends



### FLOW SENSOR

Designed to measure the velocity and volume of inhaled/exhaled gas mixture.

- ✔ Connector sizes: 15M-15M; 15M-15F.
- ✔ Flow rate: 0-120 L/min.



### CONNECTOR WITH PORT FOR N<sub>2</sub>O

Designed to deliver N<sub>2</sub>O to the patient as part of the breathing circuit.

- ✔ Connector sizes: 12M-12F.



### NEBULIZER

Designed for inhalation therapy, converting liquid medication into a fine aerosol ("mist") that penetrates the lower respiratory tract.

- ✔ Connector size: 18M.
- ✔ Connector diameter for oxygen tube: 6 mm.
- ✔ Chamber capacity: 6 ml; 20 ml.



# 02/11 ANESTHESIA AND RESUSCITATION ACCESSORIES

## ACCESSORIES

### MASK HOLDER

Designed for fixation of breathing masks on the patient's head. Elastic, with four perforated fixing straps.



### SINGLE-USE ENDOTRACHEAL TUBE

Designed for tracheal intubation for mechanical ventilation, delivery of oxygen-air mixture or inhalation anesthetic.

- ☑ Sizes: 2.0 - 10.0
- ☑ With/without cuff
- ☑ With/without reinforcement



### SINGLE-USE TRACHEOSTOMY TUBE

Designed for restoring respiratory function in patients with a tracheostomy. The tube is inserted into the tracheostomy, allowing the patient to breathe independently through the other end of the tube or, if necessary, to connect the tube to a mechanical ventilator.

- ☑ Sizes: 3.0 - 9.0
- ☑ With/without cuff



### SINGLE-USE CLOSED SUCTION SYSTEM

Designed for tracheobronchial suction without depressurization of the breathing circuit.

- ☑ Sizes: CH 6, 8, 10, 12, 14, 16
- ☑ For 24/72 hours



# 02/12 ANESTHESIA AND RESUSCITATION ACCESSORIES

## MEDICAL CONNECTORS

- ☑ Sterile/non-sterile, non-pyrogenic, non-toxic, phthalate-free.
- ☑ Single-use product.
- ☑ Protection against moisture during storage.
- ☑ Shelf life (sterility) - 5 years from the date of manufacture.

### Y-ADAPTER

Designed for connecting individual components of the breathing circuit (tubes, masks, filters, etc.) to create a closed airtight system.

#### TECHNICAL SPECIFICATIONS

- ☑ It is a single-use adapter.
- ☑ May be manufactured without ports or with temperature and capnography ports with caps, Luer port, or monitoring line connection port.

Connector sizes:  
22M-22M-22M/15F, 12F-12F-15F, 15M-15M-22M/15F, 10M-10M-15F.

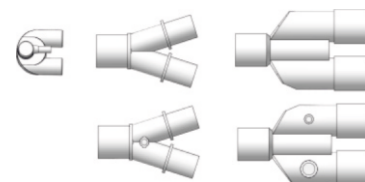

### ELASTIC ADAPTER

Designed for connecting individual components of the circuit (tubes, bags, masks, etc.) to each other, as well as to anesthesia machines, mechanical ventilators and other equipment, in order to create a closed, airtight system.

#### TECHNICAL SPECIFICATIONS

- ☑ It is a single-use adapter.

Connector sizes:  
10M-22F, 19M-22F, 15M-22F, 10 (M;F), 10F-14F/12M, 22F-23F/18M, 15F-20F/15M, 15M-15F.

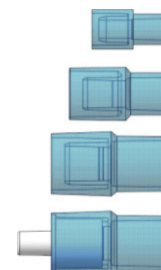

# 02/12 ANESTHESIA AND RESUSCITATION ACCESSORIES

## MEDICAL CONNECTORS

### STRAIGHT ADAPTER

Designed for connecting individual components of the circuit (tubes, bags, masks, etc.) to each other, as well as to anesthesia machines, mechanical ventilators and other equipment, in order to create a closed, airtight system.

#### TECHNICAL SPECIFICATIONS

- ☑ It is a single-use adapter.
- ☑ With/without port.

Connector sizes:  
 22M-22M, 22F-22F, 22M-22F, 15M-15F, 15M-15M, 22F-22M/15F,  
 22M-22M/15F, 15M-22F, 10M-22F, 7M-10M/7F, 10M-15F, 10M-15M,  
 10M-22M, 22M-30F, 22M-30M, 15M-22M, 22M/15F-8 mm, 15F-22M/15F,  
 15M-22M/15F, 15F-22F, 15M-8.5F.

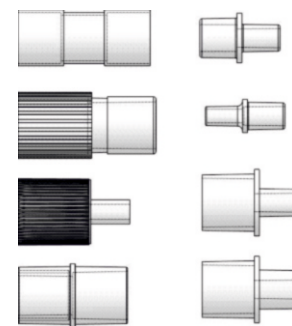
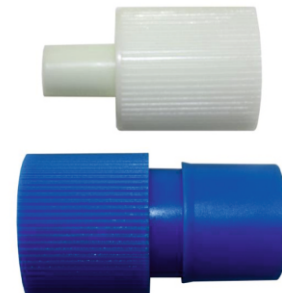

### ANGULAR ADAPTER

Designed for connecting individual components of the breathing circuit (tubes, masks, filters, etc.) to create a closed airtight system.

#### TECHNICAL SPECIFICATIONS

- ☑ It is a single-use adapter.
- ☑ May be supplied with or without port.
- ☑ May be manufactured with an extension tube: smooth-bore; corrugated; (non-)configurable, antimicrobial (violet color coding). Tube length - not less than 150 mm.

Connector sizes:

22M/15F-15M, 22F-22M, 22M/15F-22F, 22F-22F

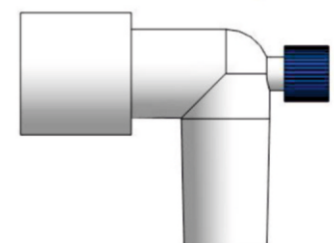
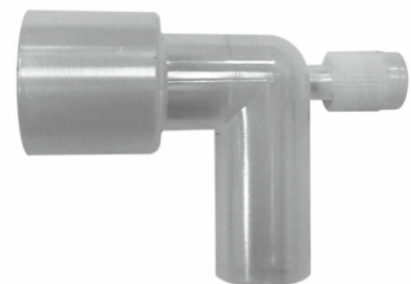

# 02/12 ANESTHESIA AND RESUSCITATION ACCESSORIES

## MEDICAL CONNECTORS

### SWIVEL ADAPTER

Used to connect the breathing circuit to a respiratory/anesthesia laryngeal mask or an endotracheal tube.

Ensures optimal and safe delivery of the respiratory gas mixture. When equipped with a sanitation and bronchoscopy port, it allows administration of medications and endotracheal aspiration when required.

Improves ergonomics and ease of use of the breathing circuit, and also provides access for sanitation of the intubation tube and bronchoscopy.

#### TECHNICAL SPECIFICATIONS

- ☑ Supplied without ports, or with a port equipped with a double hermetically locking elastic plug for sanitation and bronchoscopy, with/without extension tube.
- ☑ May be supplied with single or double swivel angular joint.
- ☑ Extension tube types: corrugated configurable/non-configurable, antimicrobial (violet color coding), smooth-bore. Tube length - not less than 150 mm.
- ☑ Manufactured from polymer materials.

Connector sizes:  
22M/15F-22F, 22M/15F-15M.

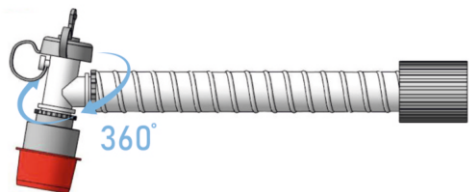
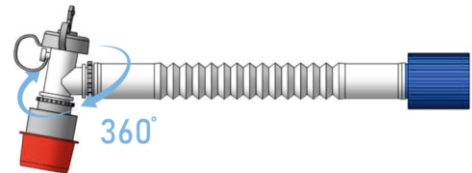
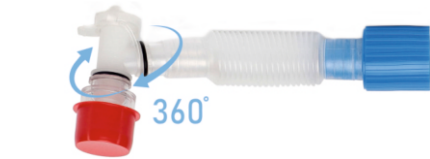

### T-CONNECTOR

Designed to connect individual components of the breathing circuit (tubes, bags, masks, etc.). Through the T-connector port, a temperature sensor can be connected, and carbon dioxide (CO<sub>2</sub>) monitoring can be performed without compromising system tightness.

#### TECHNICAL SPECIFICATIONS

- ☑ It is a single-use adapter.
- ☑ Manufactured from polymer materials.
- ☑ May be supplied with or without a port, with a cap or without a cap.

Connector sizes: 10M/7F-10M/7F-10M/7F; 10M-10M-10M; 22M/15F-22M/15F-22M/15F; 22M-22M/15F-22M; 22F-22M-22M.

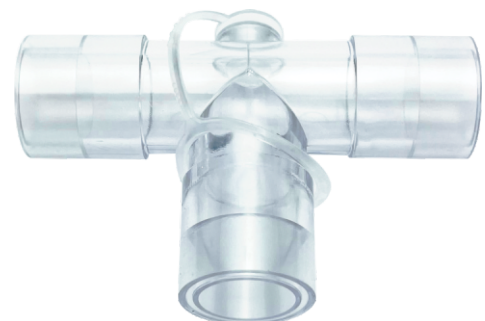

## 02/13

## ANESTHESIA AND RESUSCITATION ACCESSORIES

## LUER CAPS

## LUER CAP

Designed for closing ports and ensuring airtight sealing of various medical devices.

- ✔ Sterile/non-sterile, non-pyrogenic, non-toxic, phthalate-free.
- ✔ Single-use product.
- ✔ Protection against moisture during storage.
- ✔ Shelf life (sterility) - 5 years from the date of manufacture.



## TECHNICAL SPECIFICATIONS

- ✔ Single-use Luer caps can close ports of medical devices using several connection types: threaded connection Male type (two-start right-hand thread), female type and push-on sealing (universal cap).
- ✔ Creates airtight sealing in medical devices equipped with a Luer connector.
- ✔ Ensures sterility of the internal environment of medical devices.
- ✔ Manufactured from polymer materials.
- ✔ Available in different colors upon agreement with the customer.

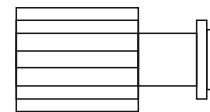

# 03 MEDICAL CATHETERS

Medical catheters are manufactured from phthalate-free polymer material.

Medical catheters produced by Asomédica Co. Ltd. are used in:

- Urology
- Proctology
- Gastroenterology
- Anesthesiology
- Surgery
- Obstetrics and others.

*\* Upon agreement with the customer, modification of the catheter length, number, size and location of openings, design of the distal end of the catheter, and replacement of the connector and nasal insert is permitted.*

*\* Manufacturing of the catheter from frozen tube is also possible.*

- Sterile/non-sterile, non-pyrogenic, non-toxic.
- Single-use product
- Protection against moisture during storage
- Shelf life (sterility) - 5 years from the date of manufacture

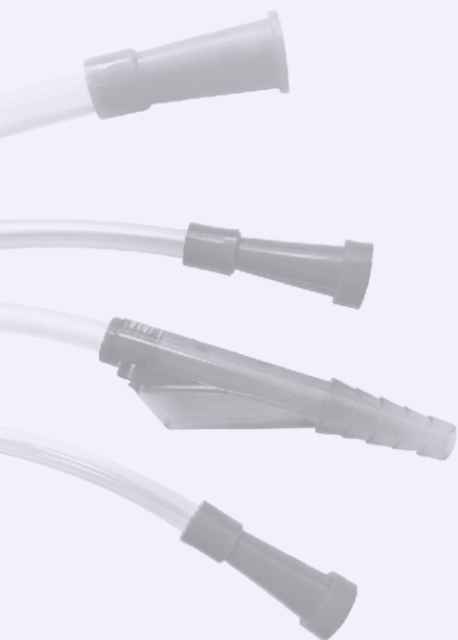

## NELATON CATHETER

☑ Male

## FEMALE CATHETER

## TIEMANN CATHETER

☑ Male

## FOLEY (TWO-WAY, THREE-WAY)

## FEEDING CATHETER

## UMBILICAL CATHETER

## GASTRIC CATHETER (TUBE)

## SUCTION CATHETER

☑ With vacuum level control

## RECTAL CATHETER

## DUODENAL CATHETER

☑ Levin suction

☑ Levin feeding

## OXYGEN CATHETER

## SURGICAL DRAINAGE CATHETER

## REDON TYPE CATHETER

## CONNECTING CATHETER (TUBE)

## TUBE IN COILS

# 03/1 MEDICAL CATHETERS

## NELATON MALE



The Nelaton catheter (male) is used in urology for single bladder drainage, administration of medications into the bladder, and bladder irrigation.

### ADVANTAGES

- ☑ The Nelaton catheter (male) is made of transparent thermoplastic implant-grade non-toxic polyvinyl chloride.
- ☑ The thermoplastic material softens under the temperature of surrounding tissues.
- ☑ The closed distal end has a rounded shape and ensures painless atraumatic insertion.
- ☑ Two lateral openings at the distal end provide optimal drainage without risk of catheter blockage.
- ☑ The non-twisting thermolabile material is resistant to bending and kinking without occluding the lumen.
- ☑ The smooth surface ensures easy insertion.
- ☑ The universal funnel-shaped connector fits any type of urine collection bag.
- ☑ A radiopaque stripe (X-ray contrast line) allows the catheter position to be determined by X-ray.
- ☑ The tube marking (metric scale) allows control of insertion depth, preventing complications and improving convenience for medical personnel.



### TECHNICAL SPECIFICATIONS

- ☑ Outer diameter D, CH - from 4 to 36, with connector color coding according to international standards.
- ☑ Length L, 100-2000 mm.
- ☑ Tube material: transparent thermoplastic implant-grade non-toxic medical PVC, phthalate-free.
- ☑ With/without tube marking.
- ☑ Tube with/without radiopaque stripe.
- ☑ Manufacturing of the catheter with lubricated coating for self-catheterization is possible.

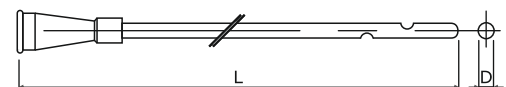

# 03/2 MEDICAL CATHETERS FEMALE



The female catheter is used in urology for single bladder drainage, administration of medicinal products into the bladder and bladder irrigation.

## ADVANTAGES

- ☑ The female catheter is made of transparent thermoplastic implant-grade non-toxic polyvinyl chloride.
- ☑ The thermoplastic material softens under the temperature of surrounding tissues.
- ☑ The closed distal end has a rounded shape and ensures painless atraumatic insertion.
- ☑ Two lateral openings at the distal end provide optimal drainage without risk of catheter blockage.
- ☑ The non-twisting thermolabile material is resistant to bending and kinking without occluding the lumen.
- ☑ The smooth surface ensures easy insertion.
- ☑ The universal funnel-shaped connector fits any type of urine collection bag.
- ☑ A radiopaque stripe (X-ray contrast line) allows the catheter position to be determined by X-ray.
- ☑ The tube marking (metric scale) allows control of insertion depth, preventing complications and improving convenience for medical personnel.



## TECHNICAL SPECIFICATIONS

- ☑ Outer diameter D, CH - from 4 to 36, with connector color coding according to international standards.
- ☑ Length L, 100-2000 mm.
- ☑ Tube material: transparent thermoplastic implant-grade non-toxic medical PVC, phthalate-free.
- ☑ With/without tube marking.
- ☑ Tube with/without radiopaque stripe.
- ☑ Manufacturing of the catheter with lubricated coating for self-catheterization is possible.

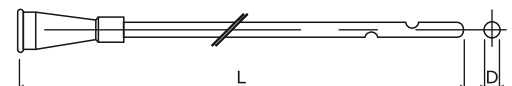

# 03/3 MEDICAL CATHETERS

## TIEMANN MALE



The Tiemann catheter (male) is used in urology for single bladder drainage, administration of medicinal products into the bladder, and bladder irrigation in men with obstructive urethral pathology.

### ADVANTAGES

- ☑ The Tiemann catheter (male) is made of transparent thermoplastic implant-grade non-toxic polyvinyl chloride.
- ☑ The thermoplastic material softens under the temperature of surrounding tissues.
- ☑ Elastic urethral catheter with a curved conical working tip, facilitating insertion of the instrument in the presence of prostatic adenoma.
- ☑ Closed atraumatic tip with two lateral openings for efficient drainage without risk of catheter blockage.
- ☑ Optimally rigid for passing through the narrowed section of the urethra.
- ☑ Non-twisting thermolabile material resistant to bending and kinking.
- ☑ The universal funnel-shaped connector fits any type of urine collection bag.
- ☑ A radiopaque stripe (X-ray contrast line) allows the catheter position to be determined by X-ray.
- ☑ The tube marking (metric scale) allows control of insertion depth, preventing complications and improving convenience for medical personnel.
- ☑ The smooth surface ensures easy insertion.



### TECHNICAL SPECIFICATIONS

- ☑ Outer diameter D, CH - from 4 to 36, with connector color coding according to international standards.
- ☑ Length L, 100-2000 mm.
- ☑ Tube material: transparent thermoplastic implant-grade non-toxic medical PVC, phthalate-free.
- ☑ With/without tube marking.
- ☑ Tube with/without radiopaque stripe.
- ☑ Manufacturing of the catheter with lubricated coating for self-catheterization is possible.

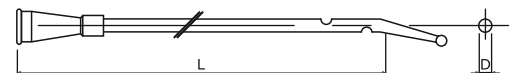

# 03/4 MEDICAL CATHETERS

## FOLEY CATHETER TWO-WAY/THREE-WAY



The Foley catheter is used in urology for prolonged bladder catheterization (not more than 7 days for latex catheters and up to 30 days for silicone catheters) and for various medical procedures.

### ADVANTAGES

- ☑ The Foley catheter is made of thermoplastic latex with silicone coating or 100% silicone.
- ☑ The 100% silicone Foley catheter reduces the risk of tissue irritation and ensures patient comfort and safety. The physicochemical properties of silicone prevent encrustation (salt deposits on the inner wall of the channel).
- ☑ Features smooth surface, closed rounded atraumatic tip, two lateral openings, and a strong symmetrical balloon.
- ☑ Universal connector compatible with any type of urine bag.
- ☑ An anti-return elastic valve allows balloon inflation using a needle-free syringe and prevents leakage of air or liquid.
- ☑ Smooth transition from the balloon to the catheter shaft reduces the risk of injury during catheterization.
- ☑ Reinforced catheter wall prevents twisting.
- ☑ Notches on both sides of the inner package allow release of the proximal and distal ends of the catheter.
- ☑ The three-way Foley catheter has an additional port for instillation and irrigation.
- ☑ The pediatric Foley catheter (CH6-CH10) is equipped with a guidewire to facilitate manipulation.
- ☑ The catheter tube may include depth marking and a radiopaque stripe along the entire tube length for accurate X-ray identification.

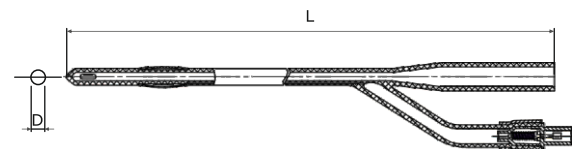
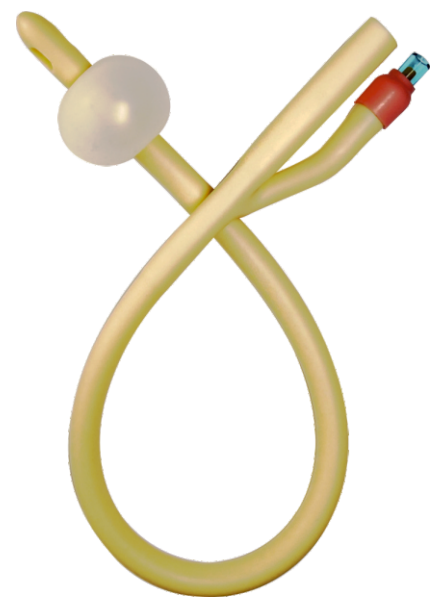

### TECHNICAL SPECIFICATIONS

- ☑ Outer diameter D, CH - from 4 to 36, connector color coding according to international standards.
- ☑ Length L - 100-2000 mm.

# 03/5 MEDICAL CATHETERS

## FEEDING



The feeding catheter is used in gastroenterology for enteral feeding and administration of medicinal products into the stomach cavity.

### ADVANTAGES

- ☑ The feeding catheter is made of transparent thermoplastic implant-grade non-toxic polyvinyl chloride.
- ☑ The thermoplastic material softens under the temperature of surrounding tissues.
- ☑ It has a closed rounded distal end, ensuring painless atraumatic insertion.
- ☑ Special positioning of the lateral openings reduces the risk of “dumping syndrome”.
- ☑ The Luer-type connector is adapted for use with automatic dosing devices.
- ☑ The hermetically closing connector cap (designed for repeated opening and closing) prevents liquid leakage and protects the catheter contents from infection.
- ☑ Smooth surface ensures easy insertion.
- ☑ The lumen does not collapse when twisted.
- ☑ A radiopaque stripe (X-ray contrast line) allows the catheter position to be determined by X-ray.
- ☑ The tube marking (metric scale) allows control of insertion depth, preventing complications and improving convenience for medical personnel.



### TECHNICAL SPECIFICATIONS

- ☑ Outer diameter D, CH - from 4 to 36, with connector color coding according to international standards.
- ☑ Length L, 100-2000 mm.
- ☑ Tube material: transparent thermoplastic implant-grade non-toxic medical PVC, phthalate-free.
- ☑ With/without tube marking.
- ☑ Tube with/without radiopaque stripe.



# 03/6 MEDICAL CATHETERS

## UMBILICAL



The umbilical catheter is used for catheterization of the umbilical vein in newborns for infusion-transfusion therapy or parenteral nutrition.

### ADVANTAGES

- ☑ The umbilical catheter is made of transparent thermoplastic implant-grade non-toxic polyvinyl chloride.
- ☑ The thermoplastic material softens under the temperature of surrounding tissues.
- ☑ The open distal end and catheter edges are carefully processed and rounded to ensure atraumatic insertion.
- ☑ A radiopaque stripe (X-ray contrast line) allows the catheter position to be determined by X-ray.
- ☑ The Luer-type connector with a hermetically closing cap (designed for repeated opening and closing) prevents liquid leakage and protects the catheter contents from infection.
- ☑ Indelible length marking with fixed increments.
- ☑ The tube marking (metric scale) allows control of insertion depth, preventing complications and improving convenience for medical personnel.
- ☑ The Luer-type connector is adapted for use with automatic dosing devices.
- ☑ Smooth surface ensures easy insertion.
- ☑ The tube lumen does not collapse when twisted.

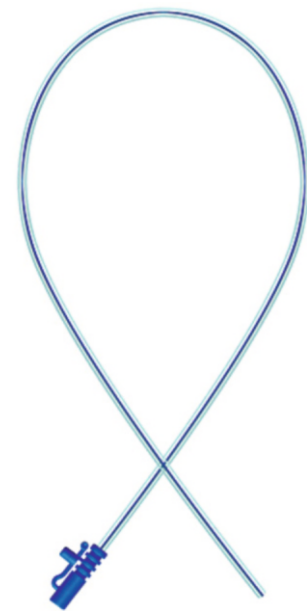

### TECHNICAL SPECIFICATIONS

- ☑ Outer diameter D, CH - from 4 to 36, with connector color coding according to international standards.
- ☑ Length L, 100-2000 mm.
- ☑ Tube material: transparent thermoplastic implant-grade non-toxic medical PVC, phthalate-free.
- ☑ With/without tube marking.
- ☑ Tube with/without radiopaque stripe.



# 03/7 MEDICAL CATHETERS

## GASTRIC (TUBE)



The gastric catheter (tube) is used in gastroenterology for aspiration of gastric contents and gastric lavage. May also be used for enteral feeding.

### ADVANTAGES

- ☑ The gastric catheter (tube) is made of transparent thermoplastic implant-grade non-toxic polyvinyl chloride.
- ☑ The thermoplastic material softens under the temperature of surrounding tissues.
- ☑ Closed rounded distal end, ensuring painless atraumatic insertion.
- ☑ Enlarged lateral openings (at least two) ensure effective passage of liquids.
- ☑ Non-twisting thermolabile material resistant to bending and kinking.
- ☑ Smooth surface ensures easy insertion.
- ☑ The lumen does not collapse when twisted.
- ☑ The funnel-shaped connector is compatible with all standard adapters.
- ☑ A radiopaque stripe (X-ray contrast line) allows the catheter position to be determined by X-ray.
- ☑ The tube marking (metric scale) allows control of insertion depth, preventing complications and improving convenience for medical personnel.

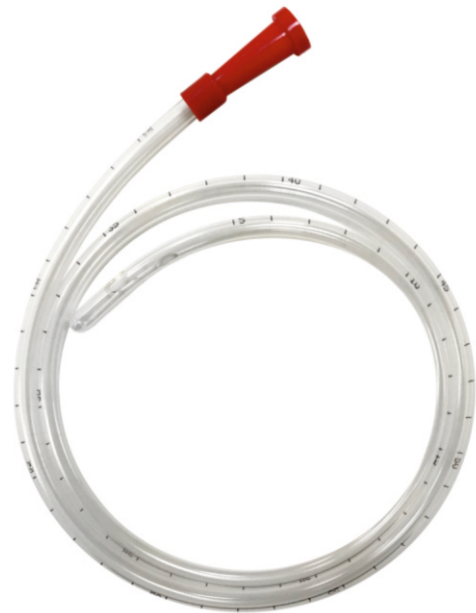

### TECHNICAL SPECIFICATIONS

- ☑ Outer diameter D, CH - from 4 to 36, with connector color coding according to international standards.
- ☑ Length L, 100-2000 mm.
- ☑ Tube material: transparent thermoplastic implant-grade non-toxic medical PVC, phthalate-free.
- ☑ With/without tube marking.
- ☑ Tube with/without radiopaque stripe.

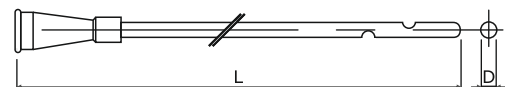

# 03/8 MEDICAL CATHETERS SUCTION



The suction catheter is used in anesthesiology for sanitation of the upper respiratory tract, including through endotracheal and tracheotomy tubes.

## ADVANTAGES

- ☑ The suction catheter is made of transparent thermoplastic implant-grade non-toxic polyvinyl chloride.
- ☑ The thermoplastic material softens under the temperature of surrounding tissues.
- ☑ Open atraumatic tip with one lateral opening.
- ☑ Connector without vacuum control compatible with standard vacuum aspirators.
- ☑ Transparent material allows visual control of aspiration.
- ☑ Non-twisting thermolabile material resistant to bending and kinking.
- ☑ The lumen does not collapse when twisted.
- ☑ A radiopaque stripe (X-ray contrast line) allows the catheter position to be determined by X-ray.
- ☑ The tube marking (metric scale) allows control of insertion depth, preventing complications and improving convenience for medical personnel.
- ☑ The smooth surface ensures easy insertion.



## TECHNICAL SPECIFICATIONS

- ☑ Outer diameter D, CH - from 4 to 36, with connector color coding according to international standards.
- ☑ Length L, 100-2000 mm.
- ☑ Tube material: transparent thermoplastic implant-grade non-toxic medical PVC, phthalate-free.
- ☑ With/without tube marking.
- ☑ Tube with/without radiopaque stripe.

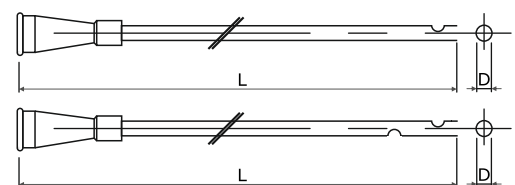

# 03/9 MEDICAL CATHETERS

## SUCTION WITH VACUUM LEVEL CONTROL



The suction catheter with vacuum control is used in anesthesiology for sanitation of the upper respiratory tract, including through endotracheal and tracheotomy tubes.

### ADVANTAGES

- ☑ The suction catheter with vacuum control is made of transparent thermoplastic implant-grade non-toxic polyvinyl chloride.
- ☑ The thermoplastic material softens under the temperature of surrounding tissues.
- ☑ Open atraumatic tip with not more than two lateral openings.
- ☑ Minimal risk of lumen obstruction by aspirate due to two auxiliary lateral openings.
- ☑ Connector with vacuum control (Vakon type or Capkon type) for manual vacuum control, compatible with all vacuum aspirators.
- ☑ Adjustable aspiration pressure (for Vakon type).
- ☑ Non-twisting thermolabile material resistant to bending and kinking.
- ☑ Specially treated surface reduces the need for lubricating agents.
- ☑ Transparent material allows visual control of aspiration.
- ☑ Smooth surface ensures easy insertion.
- ☑ A radiopaque stripe (X-ray contrast line) allows the catheter position to be determined by X-ray.
- ☑ The tube marking (metric scale) allows control of insertion depth, preventing complications and improving convenience for medical personnel.



### TECHNICAL SPECIFICATIONS

- ☑ Outer diameter D, CH - from 4 to 36, with connector color coding according to international standards.
- ☑ Length L, 100-2000 mm.
- ☑ Tube material: transparent thermoplastic implant-grade non-toxic medical PVC, phthalate-free.
- ☑ With/without tube marking.
- ☑ Tube with/without radiopaque stripe.

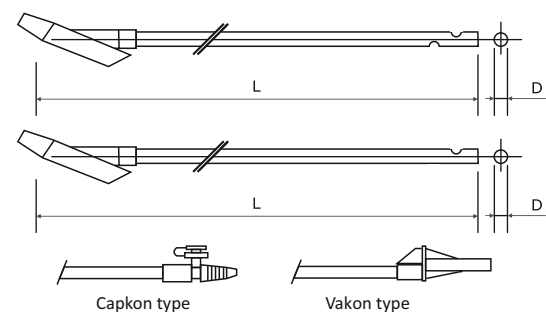

# 03/10 MEDICAL CATHETERS RECTAL



The rectal catheter is used in proctology for administration of medicinal products into the large intestine, gas evacuation and drainage of the rectum.

## ADVANTAGES

- ☑ The rectal catheter is made of transparent thermoplastic implant-grade non-toxic polyvinyl chloride.
- ☑ The thermoplastic material softens under the temperature of surrounding tissues.
- ☑ Closed rounded distal end, ensuring painless atraumatic insertion.
- ☑ Two lateral openings provide optimal drainage without risk of catheter blockage.
- ☑ Non-twisting thermolabile material resistant to bending and kinking.
- ☑ Smooth surface ensures easy insertion.
- ☑ The lumen does not collapse when twisted. Universal funnel-shaped connector.
- ☑ A radiopaque stripe (X-ray contrast line) allows the catheter position to be determined by X-ray.
- ☑ The tube marking (metric scale) allows control of insertion depth, preventing complications and improving convenience for medical personnel.



## TECHNICAL SPECIFICATIONS

- ☑ Outer diameter D, CH - from 4 to 36, with connector color coding according to international standards.
- ☑ Length L - 100-4000 mm.
- ☑ Tube material: transparent thermoplastic implant-grade non-toxic medical PVC, phthalate-free.
- ☑ With/without tube marking.
- ☑ Tube with/without radiopaque stripe.

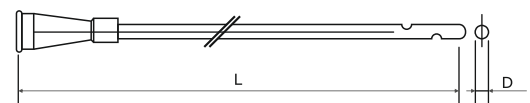

# 03/1 1 MEDICAL CATHETERS

## LEVIN DUODENAL SUCTION



The Levin duodenal suction catheter is used in gastroenterology for duodenal probing (aspiration of the contents of the duodenum).

### ADVANTAGES

- ☑ The Levin duodenal suction catheter is made of transparent thermoplastic implant-grade non-toxic polyvinyl chloride.
- ☑ The thermoplastic material softens under the temperature of surrounding tissues.
- ☑ Open atraumatic tip with four lateral openings arranged sequentially on two opposite walls of the catheter, ensuring effective drainage.
- ☑ Non-twisting thermolabile material resistant to bending and kinking, the lumen does not collapse when twisted.
- ☑ Smooth surface ensures easy insertion.
- ☑ Universal funnel-shaped connector.
- ☑ A radiopaque stripe (X-ray contrast line) allows the catheter position to be determined by X-ray.
- ☑ The tube marking (metric scale) allows control of insertion depth, preventing complications and improving convenience for medical personnel.
- ☑ Transparent tube material allows visual control of aspiration.



### TECHNICAL SPECIFICATIONS

- ☑ Outer diameter D, CH - from 4 to 36, with connector color coding according to international standards.
- ☑ Length L - 100-4000 mm.
- ☑ Tube material: transparent thermoplastic implant-grade non-toxic medical PVC, phthalate-free.
- ☑ With/without tube marking.
- ☑ Tube with/without radiopaque stripe.

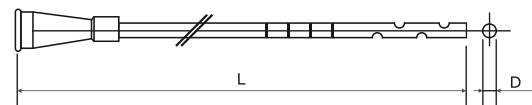

# 03/11 MEDICAL CATHETERS

## LEVIN DUODENAL FEEDING



The Levin duodenal feeding catheter is used in gastroenterology for duodenal probing (aspiration of the contents of the duodenum). May also be used for enteral feeding.

### ADVANTAGES

- ☑ The Levin duodenal feeding catheter is made of transparent thermoplastic implant-grade non-toxic polyvinyl chloride.
- ☑ The thermoplastic material softens under the temperature of surrounding tissues.
- ☑ It has a closed atraumatic tip, and four lateral openings arranged sequentially on two opposite walls of the catheter, ensuring effective passage of liquids.
- ☑ Non-twisting thermolabile material resistant to bending and kinking.
- ☑ The lumen does not collapse when twisted.
- ☑ Smooth surface does not injure or irritate biological tissues.
- ☑ Universal funnel-shaped connector.
- ☑ A radiopaque stripe (X-ray contrast line) allows the catheter position to be determined by X-ray.
- ☑ The tube marking (metric scale) allows control of insertion depth, preventing complications and improving convenience for medical personnel.



### TECHNICAL SPECIFICATIONS

- ☑ Outer diameter D, CH - from 4 to 36, with connector color coding according to international standards.
- ☑ Length L - 100-4000 mm.
- ☑ Tube material: transparent thermoplastic implant-grade non-toxic medical PVC, phthalate-free.
- ☑ With/without tube marking.
- ☑ Tube with/without radiopaque stripe.

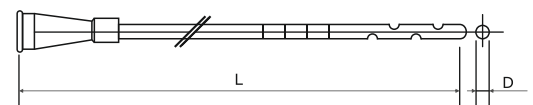

# 03/12 MEDICAL CATHETERS

## OXYGEN



The oxygen catheter (adult, pediatric, neonatal) is intended for short-term and long-term oxygen therapy. Replaces the oxygen mask. Allows the patient to eat and speak during therapy.

### ADVANTAGES

- ☑ The oxygen catheter is made of transparent thermoplastic non-toxic polyvinyl chloride.
- ☑ The thermoplastic material of the nasal cannula softens at the temperature of surrounding tissues.
- ☑ The edges of the nasal cannula are smooth and rounded, preventing trauma to the nasal mucosa and avoiding discomfort or irritation during prolonged use.
- ☑ Soft non-kinking nasal section.
- ☑ The oxygen catheter connector is compatible with systems for humidification and oxygen delivery.
- ☑ The nasal prongs may be straight or curved.
- ☑ The catheter is easily fixed in the nasal passages by adjusting the loop length.



### TECHNICAL SPECIFICATIONS

- ☑ Outer diameter D, CH - from 4 to 36, with connector color coding according to international standards.
- ☑ Length L - 100-4000 mm.
- ☑ Tube material: transparent thermoplastic implant-grade non-toxic medical PVC, phthalate-free.

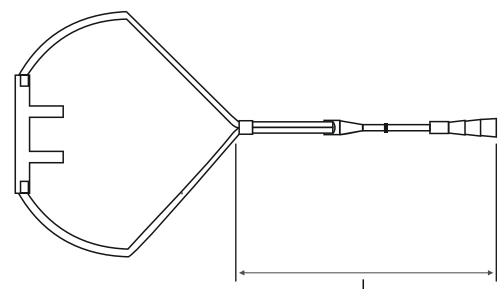

# 03/13 MEDICAL CATHETERS

## SURGICAL DRAINAGE



The surgical drainage catheter (tube) is used in surgery for removal of pathological fluids from cavities and wounds of various sizes.

### ADVANTAGES

- ☑ The surgical drainage catheter (tube) is made of transparent thermoplastic non-toxic polyvinyl chloride.
- ☑ The thermoplastic material softens under the temperature of surrounding tissues.
- ☑ It has an atraumatic open tip with at least one lateral opening.
- ☑ The lateral openings provide effective drainage without risk of blockage (number of openings according to customer requirements).
- ☑ Non-twisting thermolabile material resistant to bending and kinking.
- ☑ The lumen does not collapse when twisted.
- ☑ Connected to bellows reservoirs for active drainage.
- ☑ A radiopaque stripe (X-ray contrast line) allows the catheter position to be determined by X-ray.
- ☑ The tube marking (metric scale) allows control of insertion depth, preventing complications and improving convenience for medical personnel.



### TECHNICAL SPECIFICATIONS

- ☑ Outer diameter D, CH - from 4 to 36, with connector color coding according to international standards.
- ☑ Length L - 100-20000 mm.
- ☑ Tube material: transparent thermoplastic implant-grade non-toxic medical PVC, phthalate-free.
- ☑ With/without tube marking.
- ☑ Tube with/without radiopaque stripe.

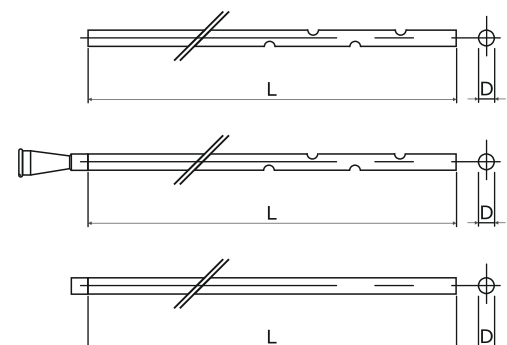

# 03/14 MEDICAL CATHETERS

## REDON TYPE



The Redon-type catheter is used in surgery for removal of blood and exudate from the operated area.

### ADVANTAGES

- ☑ The Redon-type catheter is made of transparent thermoplastic non-toxic polyvinyl chloride.
- ☑ The thermoplastic material softens under the temperature of surrounding tissues.
- ☑ It has an atraumatic open tip.
- ☑ Equal-sized lateral openings are arranged symmetrically on two opposite walls of the catheter (number of openings according to customer agreement), ensuring effective drainage without risk of blockage.
- ☑ Non-twisting thermolabile material resistant to bending and kinking.
- ☑ The lumen does not collapse when twisted.
- ☑ A radiopaque stripe (X-ray contrast line) allows the catheter position to be determined by X-ray.
- ☑ The tube marking (metric scale) allows control of insertion depth, preventing complications and improving convenience for medical personnel.
- ☑ The smooth surface ensures easy insertion.

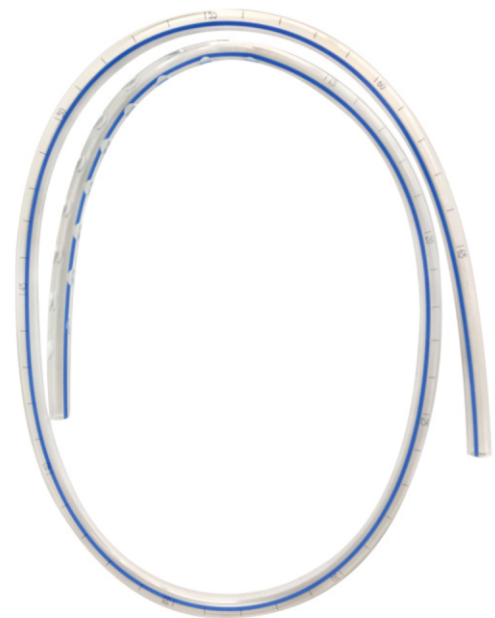

### TECHNICAL SPECIFICATIONS

- ☑ Outer diameter D, CH - from 4 to 36, with connector color coding according to international standards.
- ☑ Length L - 100-20000 mm.
- ☑ Tube material: transparent thermoplastic implant-grade non-toxic medical PVC, phthalate-free.
- ☑ With/without tube marking.
- ☑ Tube with/without radiopaque stripe.

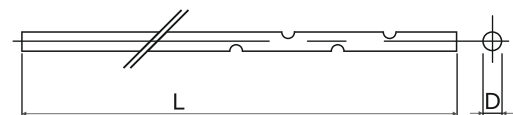

# 03/15 MEDICAL CATHETERS CONNECTING (TUBE)

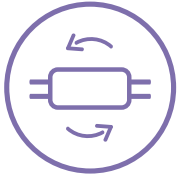

The connecting catheter (tube) is used as an extension line, drainage line, or flexible connection in medical devices.

## ADVANTAGES

- ☑ The connecting catheter (tube) is made of transparent thermoplastic non-toxic polyvinyl chloride.
- ☑ It has an atraumatic open tip.
- ☑ Available without connectors, with one connector, or with two connectors.
- ☑ Transparent material allows visual monitoring.
- ☑ Tubes are resistant to adhesion during reverse bending.
- ☑ Possibility of connection through connectors with tubes of different diameters.
- ☑ A radiopaque stripe (X-ray contrast line) allows the catheter position to be determined by X-ray.
- ☑ The tube marking (metric scale) allows control of insertion depth, preventing complications and improving convenience for medical personnel.



## TECHNICAL SPECIFICATIONS

- ☑ Outer diameter D, CH - from 4 to 36, with connector color coding according to international standards. Length L - 100-20000 mm.
- ☑ Tube material: transparent thermoplastic implant-grade non-toxic medical PVC, phthalate-free.
- ☑ With/without tube marking.
- ☑ Tube with/without radiopaque stripe.

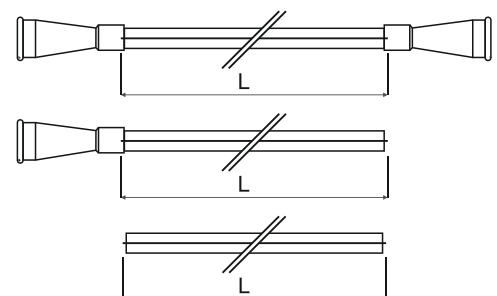

# 03/16 MEDICAL CATHETERS

## TUBE IN COILS

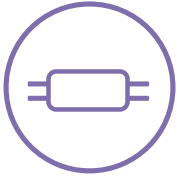

Tube in coils is intended for catheterization, probing, manufacture of drainage systems, devices for blood transfusion, blood substitutes and infusion solutions, as well as for assembly of pump and other medical devices and connection with surgical equipment and instruments.

### ADVANTAGES

- ☑ The tube is made of transparent thermoplastic non-toxic polyvinyl chloride.
- ☑ The thermoplastic material softens under the temperature of surrounding tissues.
- ☑ The smooth tube surface ensures effective fluid outflow.
- ☑ Non-twisting thermolabile material resistant to bending and kinking.
- ☑ The lumen does not collapse when twisted.
- ☑ Transparent tube material allows visual monitoring.
- ☑ A radiopaque stripe (X-ray contrast line) allows the catheter position to be determined by X-ray.
- ☑ The tube marking (metric scale) allows control of insertion depth, preventing complications and improving convenience for medical personnel.



### TECHNICAL SPECIFICATIONS

- ☑ Outer diameter D, CH - 4 to 36.
- ☑ Tube material: transparent thermoplastic implant-grade non-toxic medical PVC, phthalate-free.
- ☑ With/without tube marking.
- ☑ Tube with/without radiopaque stripe.
- ☑ Tube length according to customer agreement.

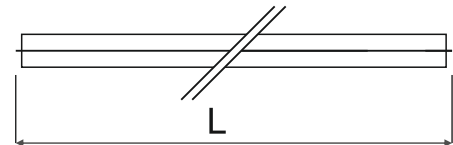

# 04 MEDICAL URINE BAGS

Bedside and leg urine bags are equipped with a drain valve, a non-return valve to prevent backflow of liquid, and a graduated scale for monitoring the volume of urine output.

**Asomedica Co. Ltd. offers a wide range of urine bags: bedside, leg (wearable), and pediatric, designed to improve the quality of life of patients.**

- ✔ Sterile/non-sterile, non-pyrogenic, non-toxic, phthalate-free.
- ✔ Single-use product
- ✔ Protection against moisture during storage
- ✔ Shelf life (sterility) - 5 years from the date of manufacture

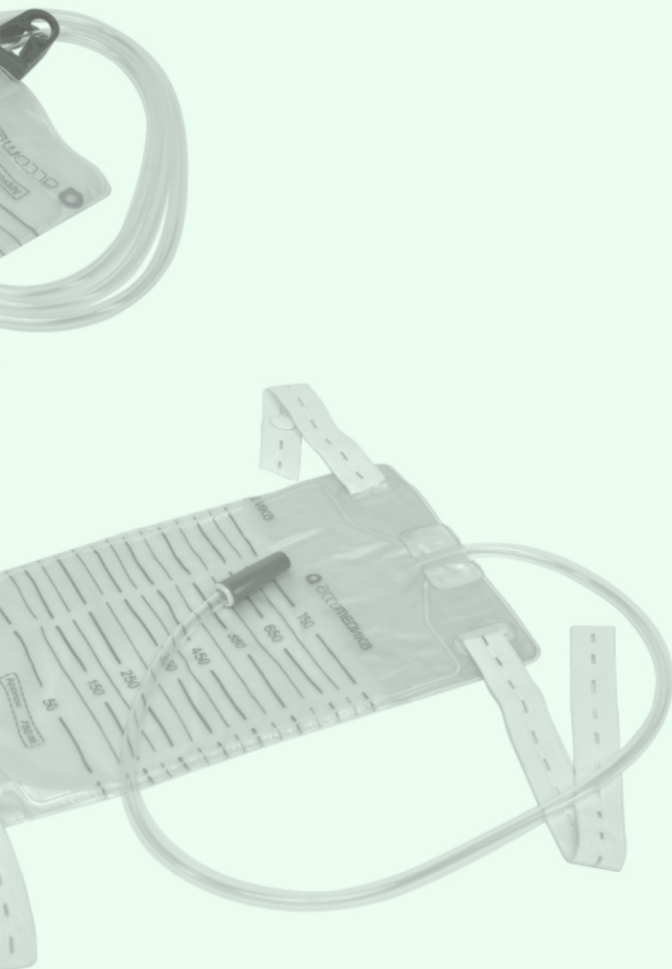

## BEDSIDE URINE BAGS

## LEG URINE BAGS

## ESMARCH'S IRRIGATOR

# 04/1 MEDICAL URINE BAGS BEDSIDE

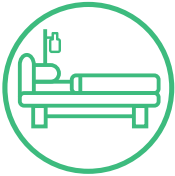

The urine bag is intended for urine drainage (collection) from the bladder through a catheter. Used in hospital settings when the patient is in a lying position, attached to the patient's bed.

## ADVANTAGES

- ✔ Equipped with a non-return urine valve.
- ✔ A drain valve at the bottom of the bag (T-shaped, screw-type or other) allows the urine bag to be emptied when necessary.
- ✔ The walls of the urine bag are transparent for better visibility of urine color and volume.
- ✔ The volume of collected liquid is easily read on the scale located on the front side of the urine bag.
- ✔ Equipped with a long, flexible drainage tube resistant to bending and kinking. At the end of the tube there is a conical connector with a cap, compatible with any size and type of catheter.
- ✔ Equipped with reinforced rings for fastening the urine bag.
- ✔ Urine bags are supplied with fastening systems, and the fastening devices can also be purchased separately.



## TECHNICAL SPECIFICATIONS

- ✔ Sterile (sterilization method - ethylene oxide gas)/non-sterile.
- ✔ Manufactured from polymer materials.
- ✔ The urine bag has graduation in milliliters.
- ✔ Capacity of bedside urine bags from 500 ml to 4000 ml.
- ✔ Drainage tube length from 6 to 200 cm.

## ACCESSORIES FOR BEDSIDE URINE BAGS:

- Fastening

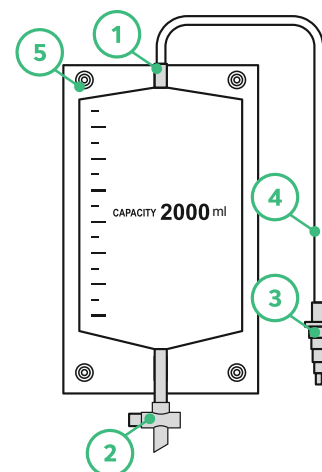

- 1 Non-return valve (NRV)
- 2 Drain valve
- 3 Universal connector
- 4 Flexible drainage tube
- 5 Reinforced rings for fastening the urine bag

# 04/2 MEDICAL URINE BAGS LEG



The urine bag is intended for urine drainage (collection) from the bladder through a catheter. Suitable for patients who are mobile and lead an active lifestyle, providing comfort and freedom of movement. Supplied with fixing straps for attachment to the leg, which do not restrict the patient's social activity.

## ADVANTAGES

- ☑ Equipped with a non-return urine valve.
- ☑ Drain valve at the bottom of the bag (T-shaped, screw-type or other).
- ☑ Transparent bag walls allow clear visibility of urine color and volume.
- ☑ The volume of collected liquid is easily read on the scale located on the front side of the urine bag.
- ☑ Equipped with a flexible tube resistant to bending, with a conical connector and cap compatible with any catheter type and size.
- ☑ Can be attached either to the thigh or the calf.
- ☑ Secure fastening using fixing straps.
- ☑ The tightness of the fixing straps is adjustable with a special clasp.
- ☑ Designed for both men and women.
- ☑ Can also be used as a bedside urine bag if necessary.



## TECHNICAL SPECIFICATIONS

- ☑ Manufactured from polymer material that does not irritate the skin. The rear side of the urine bag may be made of nonwoven material (soft backing)
- ☑ The urine bag has graduation in milliliters.
- ☑ Capacity of leg urine bags from 500 ml to 2000 ml.
- ☑ Drainage tube length from 6 to 200 cm.

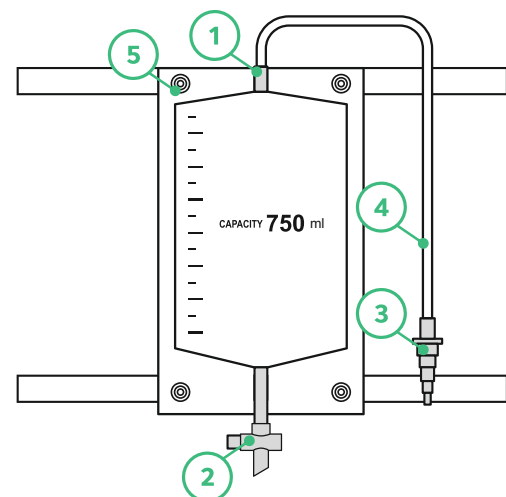

- 1 Non-return valve (NRV)
- 2 Drain valve
- 3 Universal connector
- 4 Flexible drainage tube
- 5 Reinforced rings for fixing straps
- 6 Fixing strap